

OPERATING MANUAL VR 969/02

Dear customer,
with this video recorder (VCR), you own one of the most sophisticated yet simple-to-use video recorders on the market.

Naturally, you can't wait to use your new video recorder, but before you start, it's worthwhile taking the time to read through this operating manual. Acquainting yourself with the video recorder's features is the best way to guarantee trouble-free operation.

This video recorder is supplied with additional **abridged operating instructions** which are to be found in its packaging.

If you should nevertheless get difficulties in operating this video recorder, please contact a **consumer help desk** responsible for your country. You will find the telephone numbers in the guarantee information supplied.

Safety instructions

- This video recorder is intended for the reception, recording and playback of picture and sound signals. Every other use is explicitly excluded.
- Danger - high voltage in this appliance!
Do not open! The video recorder does not contain any parts that can be repaired by the user. As long as the video recorder is connected to the mains, there are parts of it still in operation. To switch off the video recorder completely you must disconnect it from the mains.
- Please note that this video recorder is intended for a mains voltage of 220 - 240V~, /50Hz.
- The manufacturer cannot be held responsible for any damage which is incurred by not using the video recorder in compliance with the national guarantee conditions or safety instructions.
- Ensure that no objects or liquids enter the device. If a liquid enters, pull out the power plug of the video recorder immediately and consult customer services.

Contents	Page
1. BUTTONS, CONTROLS AND SOCKETS	2
The remote control at a glance	2
The back of the video recorder	3
The front of the video recorder	3
2. INSTALLATION. HOW DO I INSTALL THE VIDEO RECORDER ?	5
Connecting the video recorder	5
Inserting the batteries into the remote control	6
Connecting to the aerial	6
Connecting to the TV set	7
Connecting to the mains supply	7
Some notes on operation	7
Saving energy	8
Further connecting possibilities	8
Emergency interrupt	8
OSD – the on-screen user's guide	9
3. STORING TV CHANNELS	10
The "Easy Link" function	10
Automatic channel search (ATS Euro+)	10
Assigning TV channels automatically (Follow TV)	11
Assigning TV channels manually	12
Manual search	13
4. PLAYING A RECORDED CASSETTE	14
S-VHS Playback	14
The JOG/SHUTTLE functions	15
5. HOW CAN I RECORD DIRECTLY ?	18
Direct recording	19
6. HOW DO I PROGRAMME A RECORDING ?	20
Programming with ShowView	21
Programming with TXT pages	22
Normal TIMER programming	23
Recording from a satellite receiver	24
Checking, correcting and clearing a TIMER block	25
7. EDITING VIDEO RECORDINGS	27
Audio dubbing	27
The Insert functions	29
Synchro-edit	30
Insert-edit functions	33
Programme-edit functions	35
8. ADDITIONAL FUNCTIONS OF THE RECORDER	37
Personal preferences	37
Checking/setting time and date on the video recorder	37
Special settings for the video recorder and the TV set	38
9. NOTES	45
10. BEFORE YOU CALL A TECHNICIAN	46
11. TECHNICAL DATA, ACCESSORIES	47

1. BUTTONS, CONTROLS AND SOCKETS

For detailed explanations of the functions, see the corresponding chapters.

The remote control



- RECORD ●** Recording
- STANDBY ⏻** Switching off
- ▲ / ▼ / ◀ / ▶** Cursor up/down, left/right
- MENU** Call up the OSD page MAIN MENU
- OK** Confirm entry
- CLEAR** Reset/clear
- TIMER ⌚** TIMER programming
- SELECT** Select function
- 0 - 9** Numeric buttons
- ◀◀** Rewind/picture search reverse
- PLAY ▶** Playback
- ▶▶** Wind/picture search forwards
- INDEX ▶|** Search index mark
- STILL / JOG ON ▶|◀** Still picture, Jog/Shuttle on/off
- STOP ■** Stop/Pause
- INSTANT VIEW** Picture search during fast wind
- COUNTER** Tape counter
- MONITOR** TV monitor function
- ⊙** Jog/Shuttle

Additional TV functions: only for TV sets with the **same** remote control code.

- TV ▲ / ▼** TV volume +/-
- TV 🔊** TV sound on/off
- TV ⏻** TV off
- TV P +/-** TV programmes +/-

The back of the video recorder

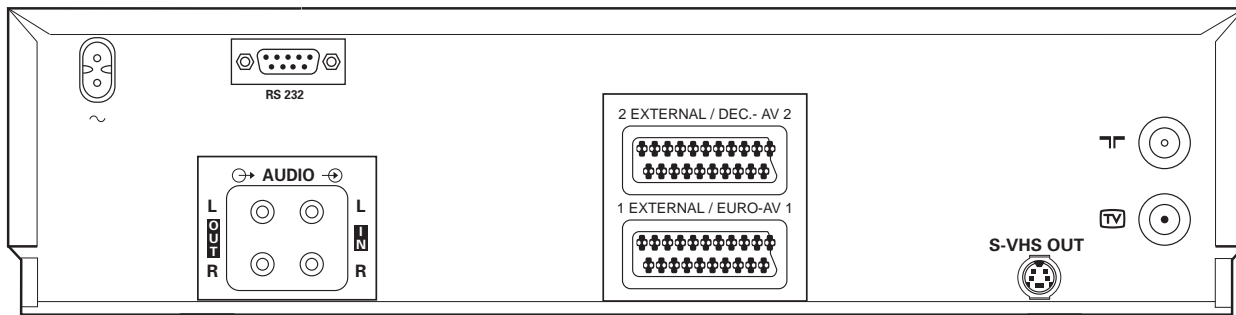

- Mains socket
- RS 232** Socket for the connection of a cutting device or a personal computer
- 2 EXTERNAL / DEC.-AV 2** Scart socket DEC.-AV 2
- 1 EXTERNAL / EURO-AV 1** Scart socket EURO-AV 1
- S-VHS OUT** S-VHS output socket
- AUDIO L OUT R** Audio output, left/right channel
- AUDIO L IN R** Audio input, left/right channel
- Aerial input socket
- Aerial output socket

The front of the video recorder

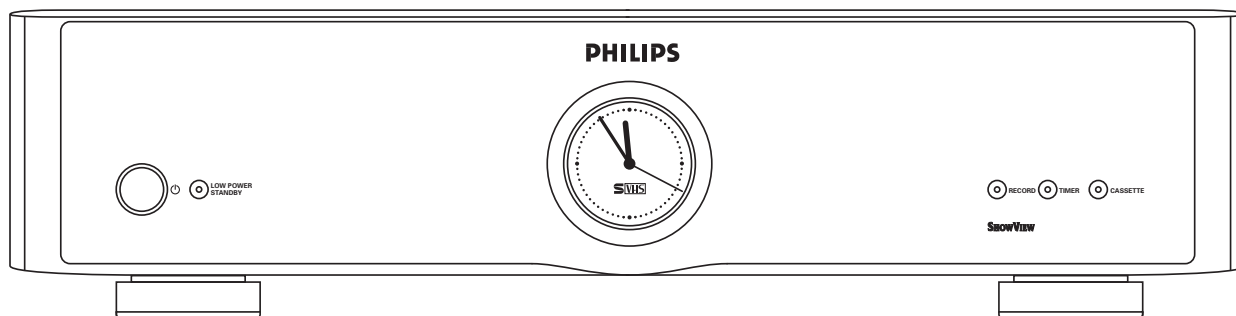

Buttons and display indicators on the front cover:

- Switch off/switch on
- Analog clock
- LOW POWER/STANDBY Red pilot lamp = off
- Green pilot lamp = on
- RECORD = Recording start indicator
- TIMER = TIMER programming indicator
- CASSETTE = Cassette indicator

The front of the video recorder

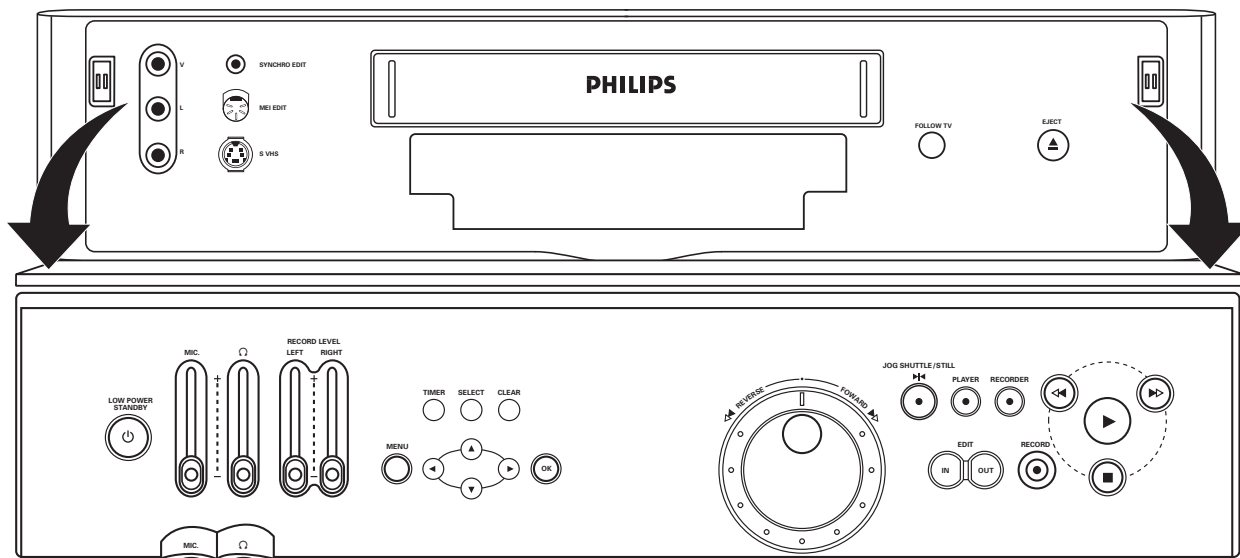

Buttons and connections behind the front cover:

- V** Video input socket (E3)
- L** + **R** Left/Right, Audio input sockets, (for E3 and E4)
- SYNCHRO EDIT** Synchro-edit socket
- MEI EDIT** MEI-edit socket
- S VHS** S-VHS input socket (E4)
- FOLLOW TV** Automatic channel search
- EJECT** Eject cassette

Buttons and connections in the front cover:

- ⏻** Switch off/switch on
- MIC. - / +** Microphone level control
- MIC.** Mikrophone socket
- 🎧 - / +** Headphone level control
- 🎧** Headphone socket
- L RECORD LEVEL R** Recording level control, left/right
- TIMER** TIMER programming on the video recorder
- SELECT** Select function
- CLEAR** Reset/clear
- MENU** Call up the OSD page MAIN MENU
- ▲ / ▼ / ◀ / ▶** Cursor up/down, left/right
- OK** Confirm entry
- JOG SHUTTLE / STILL** Jog/Shuttle
- JOG SHUTTLE / STILL** Still picture on playback, Jog/Shuttle on/off
- PLAYER** Switch to camcorder mode
- RECORDER** Switch to video recorder mode
- EDIT IN** Mark beginning of scene
- EDIT OUT** Mark end of scene
- ◀◀** Rewind/ reverse picture search
- ▶▶** Fast forward/ forward picture search
- ▶** Playback
- RECORD ●** Recording
- Stop/Pause

2. INSTALLATION. HOW DO I INSTALL THE VIDEO RECORDER ?

Connecting the video recorder

The scart socket **1 EXTERNAL / EURO-AV 1** has an input/output function. Connect your TV set to this socket. The socket **2 EXTERNAL / DEC.-AV 2** has an input function. Connect additional units to this socket. A detailed explanation to this illustration is to be found in the next paragraphs.

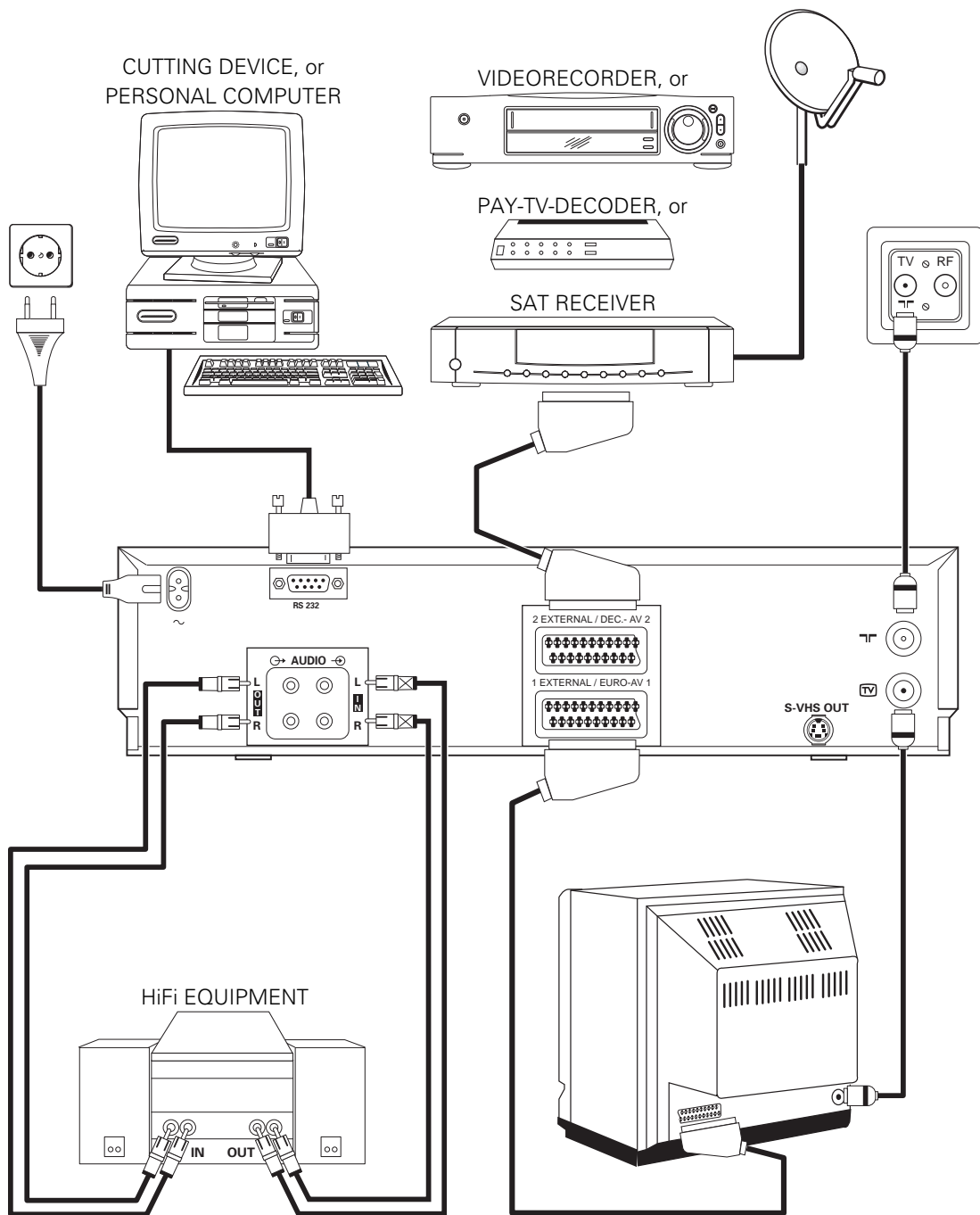

Inserting the batteries into the remote control

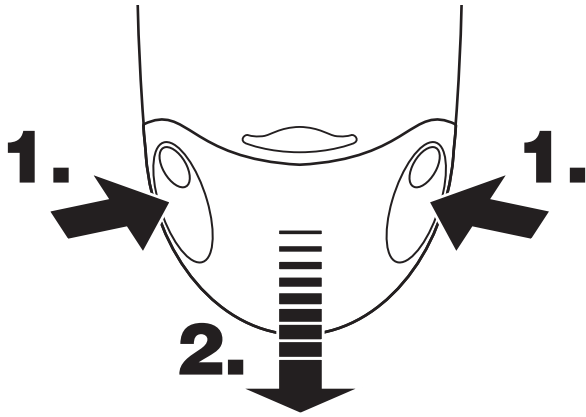

- 1 Remove the battery holder from the back of the remote control.
To do this, squeeze the holder at the lateral marks (1.) and pull it off (2.).
- 2 Insert the batteries as indicated in the battery holder.
- 3 Close the battery holder by sliding it into the remote control until you hear a "click"



Note:

* So that the battery operates correctly, it must always be pointed at the TV set.

Connecting to the aerial

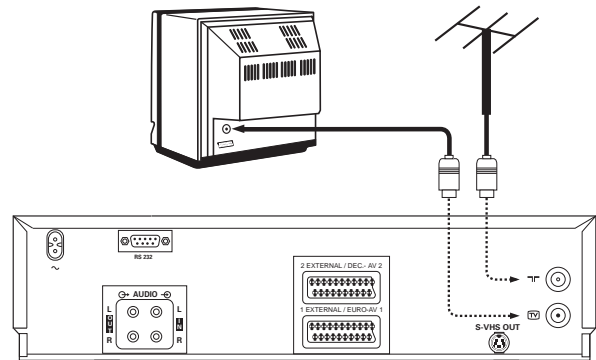
Your video recorder could actually be referred to as a "TV set without picture screen". This is why you have to connect it to an aerial as well as to a TV set. Only then you can make recordings and play cassettes.



- 1 Remove the aerial cable plug from the TV set and insert it into the  socket at the rear of the video recorder.
- 2 Use the aerial cable supplied to connect the  socket on the video recorder with the aerial input socket on your TV set.

Both the TV set and the video recorder are now connected to the aerial.

Connecting to the TV set

If your TV set **does not have a Scart (Euro-AV) socket**, do **not read here** but continue with chapter 8, "Additional functions of your video recorder". In the chapter "Playback via the aerial cable" you will find the required information.

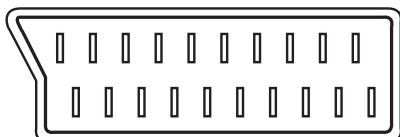

- 1 Insert one plug of the Scart cable supplied into the Scart socket **EURO-AV 1** on the back panel of the video recorder. Insert the other plug of the Scart cable into the Scart socket on the TV set.

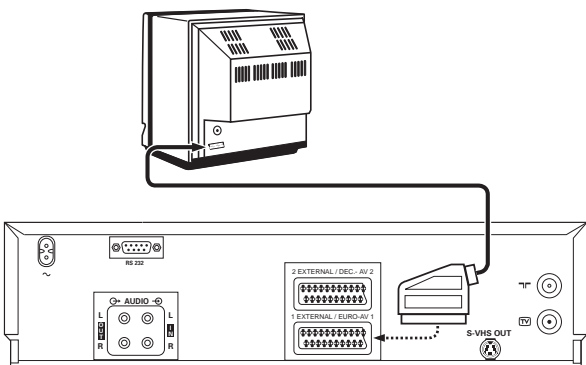

- 2 Many TV sets **automatically** switch over to the programme position "EXT" (**External**) or "AV" (**Audio/Video**) with the help of this cable connection when playback is started on the video recorder.

For other TV sets, select the programme position "EXT", "0" or "AV" for video playback manually on the TV set. How this is done is to be found in the operating instructions of the TV set.

Notes:

- * If your TV set has several Scart sockets, select the socket which has a video input and output function.
- * If your TV set allows for selecting the video source via a menu, select "TV" as source for this Scart socket.

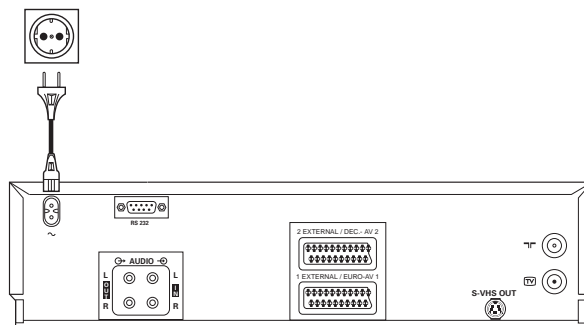

Connecting to the mains supply



- 1 Insert the female plug of the mains cable into the mains socket  at the rear of the video recorder.
- 2 Insert the other plug of the mains cable into the wall socket.

Your video recorder is now **properly** connected.

Some notes on operation

- The video recorder should permanently be connected to the mains supply to enable programmed recordings and TV operation. The energy consumption is very low.
- The video recorder is automatically switched on when inserting a cassette (the  symbol lights up in the video recorder's display) or when pressing the **STOP**  button.



- If the video recorder is not used for a few minutes, it is automatically switched off.

Saving energy

There are two ways of switching off to choose from.

1. Normal switch-off.

Switch off by pressing the button . The time remains visible.

2. Energy-saving mode.

Press the button  once again.

The time in the display disappears. You can switch back on again by pressing the same button.

Note:

* It is not possible to switch to energy-saving mode as long as a TV set connected with a scart cable is switched on. "TV ACTIVE" appears in the video-recorder's display.

* After switching the video recorder in the „Saving energy mode“, the analogic clock cannot set/correct itself automatically.

Connecting to a decoder

Some TV stations transmit encoded (encrypted) signals which you can only decode for viewing if you use a bought or hired decoder (descrambler).

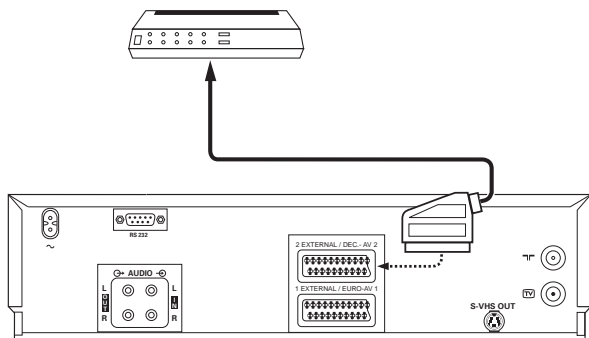

- 1 Connect the decoder with a Scart cable to the **DEC.-AV 2** socket on the video recorder.

How to programme the decoder function when storing TV channels is described in the chapter "**Storing TV channels**".

Notes:

* It is not possible to use the decoder at the same time for the video recorder and the TV set.
* The video recorder will automatically use the decoder when a programme position is selected on the video recorder which has been assigned to the decoder function when storing TV channels.

Connecting to a satellite receiver

It is possible to connect a satellite receiver to this video recorder.

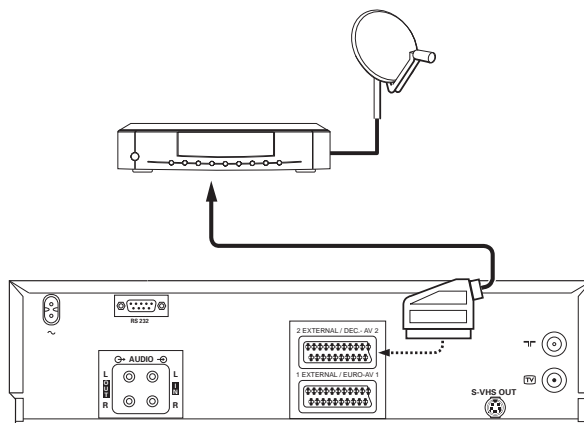

- 1 Connect the satellite receiver by means of a Scart cable to the video recorder (socket **DEC.-AV 2**).
- 2 Switch the video recorder on and select the programme position "E 2".

Connecting to hifi equipment

You can play the sound of your video recorder via your hifi equipment.

- 1 Connect the **AUDIO L IN R** and **AUDIO L OUT R** sockets on the back of your video recorder with the corresponding sockets on your hifi equipment.
A cable can be purchased at a specialized dealer.

Emergency interrupt

The video recorder and the remote control have an emergency interrupt function. You can interrupt any function by pressing the **STANDBY**  button.

Whenever you have any problems while operating the video recorder, you can simply interrupt any function and start again.

You can practise using the video recorder without worrying. No matter which button you press, you won't damage the video recorder.

OSD – On Screen Display, the user's guide on the picture screen

The user's guide on the picture screen enables you to dialogue with your video recorder. The indications given in the bottom line of the picture screen designate the buttons on the remote control which are to be used to carry out the various functions. You will be guided in a simple and understandable way to the next possible operating steps. The following example explains the user's guide with the help of the "MAIN MENU".

- 1 Switch the TV set on and select the programme position for the video recorder (e.g. "EXT", "0" or "AV").

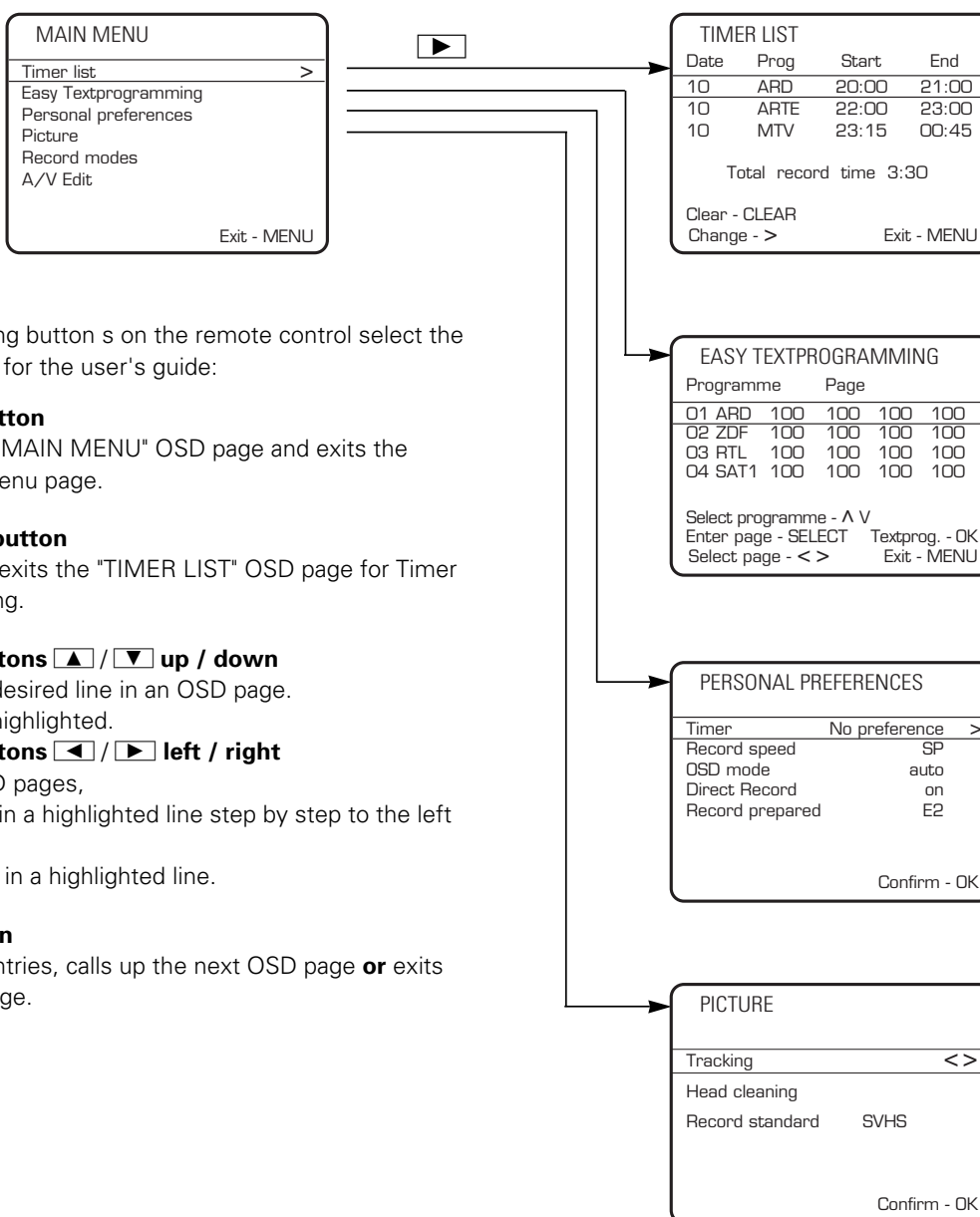

The following buttons on the remote control select the OSD pages for the user's guide:

MENU button

Opens the "MAIN MENU" OSD page and exits the called up menu page.

TIMER button

Opens and exits the "TIMER LIST" OSD page for Timer programming.

Cursor buttons **▲** / **▼** up / down

Select the desired line in an OSD page. The line is highlighted.

Cursor buttons **◀** / **▶** left / right

Call up OSD pages, select data in a highlighted line step by step to the left and right switch data in a highlighted line.

OK button

Confirms entries, calls up the next OSD page or exits the OSD page.

3. STORING TV CHANNELS

In order that your video recorder can record TV programmes, the TV channels (e.g. "ARD") must first be stored in the video recorder. You can store up to 99 TV channels. Your video recorder has a receiver of its own. This means it can be used independently of the TV set.

The "Easy Link" function



This function enables your video recorder to exchange information with the TV set. For this reason, also take note of the operating instructions that accompany your TV set.

The TV set and video recorder (EURO-AV 1 scart socket) must be connected using the **special scart cable supplied** and your TV set must **have** the "Easy Link" function.

- 1 Switch on the TV set.
- 2 Pull out the mains plug and plug it back in again.
- 3 The video recorder automatically loads all of the TV channels stored in the TV set in the correct order. This can take a few minutes.
The following display appears on screen:
"EASY LINKL Loading from TV – please wait",
"EASY LINK" appears in the video-recorder's display.
Once all TV channels have been found, the video recorder switches itself off.
- 4 Select the desired display language. To do this, press the button **FOLLOW TV** on the video recorder.
- 5 The OSD page "LANGUAGE" appears on screen. Select the desired display language.
- 6 Confirm the setting by pressing the button **OK**. The OSD page "COUNTRY" appears on screen. Select your country.
- 7 Confirm the setting by pressing the button **OK**. "EASY LINK" appears briefly in the videorecorder display.

It is still possible at this stage to assign special functions to certain channel numbers. For further information, see the section "Manual search".

Automatic channel search (ATS Euro+)

The ATS Euro + function is not possible if the connected TV set has "Easy Link".

The video recorder will make a search for all TV channels. It stores them in a logical sequence in the memory.

- 1 Switch the TV set on and select the channel number for the video recorder.
- 2 Press the button **FOLLOW TV** on the video recorder.
- 3 The OSD page "LANGUAGE" appears on the screen. Select the display language desired.



- 4 Confirm by pressing the button **OK**. The OSD page "COUNTRY" appears on screen. Choose your country.
- 5 Confirm by pressing the button **OK**. The automatic tuning begins.
- 6 Wait until all TV channels have been found. This may take a few minutes.
Once all TV channels have been found, a message, e.g. "ATS Euro+ ready 28 TV channels found" appears on screen. The automatic channel search is over.
- 7 Press the button **OK**. The OSD page "INSTALLATION MENU" appears on screen.
- 8 Complete the setting by pressing the button **MENU**.

Note:
 * When an ATS Euro+ is restarted, the "INSTALLATION MENU" appears after Step 2.
 Select "ATS Euro+" and proceed with Step 6.
 TV channels already stored will be retained. If the message "FULL" appears briefly in the video recorder's display, all of the video recorder's channel storage places have been occupied.

For details of how to change the sequence, please read the section entitled "Assigning TV channels". At this stage, you can still determine special functions for certain channel numbers. See the section "Manual search" for further information.

Assigning TV channels automatically (Follow TV)

The following setting is not necessary if the TV channels have been set using the "Easy Link" function.

Only if the video recorder (socket **EURO-AV 1**) and the TV set are connected **by means of a scart cable** can the TV channels be allocated automatically. This means that the video recorder takes on the same channel sequence as the TV set.

- 1 Switch the TV set on and select the channel number for the video recorder.
- 2 Press the button **FOLLOW TV** on the video recorder.
- 3 Select the line "Follow TV". Press the button **▶**.

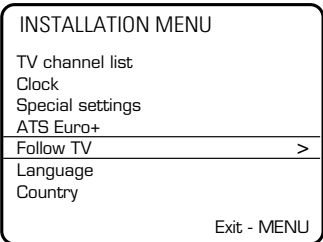

- 4 The video recorder's display indicates "SELECT TV P01".



- 5 Select the programme position "1" on the TV set.

- 6 Confirm with the **OK** button on the video recorder's remote control. The video recorder's display indicates "WAIT". The video recorder compares its programme positions with the programme positions of the TV set. If the programme position on the video recorder and on the TV set is the same (e.g. "P 01"), the video recorder loads the TV channel from the TV set.

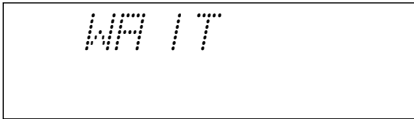

- 7 Wait until the video recorder's display indicates, for example, "SELECT TV P02".

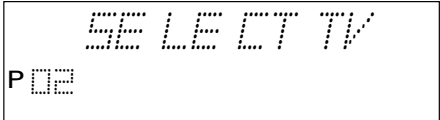

- 8 Select the programme position "2" on the TV set.
- 9 Confirm with the **OK** button on the video recorder's remote control. The video recorder's display indicates "WAIT".
- 10 Repeat the steps 7 to 9 until all TV channels are allocated.
- 11 Press the **MENU** button to terminate the adjustment. The video recorder's display indicates briefly "READY".

It is possible to assign special functions to certain programme positions. This is explained in the paragraph "Manual search".

Assigning TV channels manually

The following setting is not necessary if the TV channels have been set using the "Easy Link" function.

You can allocate any TV channel found to the programme number of your choice so that you have, for example, the same TV channel sequence as on your TV set.

- 1 Switch on the TV set and select the programme number for the video recorder.
- 2 Call up the "INSTALLATION MENU" by pressing button **[FOLLOW TV]**. The line "TV channel list" becomes active.
- 3 Confirm the line by pressing the button **[▶]**. The "TV CHANNEL LIST" appears. The last programme number selected, e.g. "01", becomes active.
- 4 Select the TV channel that you wish to move by pressing the button **[▼]** or **[▲]**. Press the button **[▶]**.

TV CHANNEL LIST			
PR	CH	NAME	DEC
01	C28	ARD	off
02	C25	ZDF	off
03	C42	BR3	off
04	C40	SAT1	off
05	C36	RTL	off
06	C21	RTL2	off
07	S18	PREM	on

Select - > Exit - MENU

- 5 Using the button **[▼]** or **[▲]**, move the TV channel to the desired programme number.

TV CHANNEL LIST			
PR	CH	NAME	DEC
01	C28	ARD	off
02	C25	ZDF	off
03	C42	BR3	off
04	C40	SAT1	off
05	C36	RTL	off
06	C21	RTL2	off
07	S18	PREM	on

Insert - SELECT Move - ^V
Change - > Confirm - OK

- 6 Confirm by pressing the button **[OK]**. The TV channel line is inserted and the other channel lines are moved on a line. If you wish to cancel an **undesired** TV channel, press the button **[CLEAR]** instead of button **[OK]**.
- 7 Sort all of the TV channel lines (steps 4 - 6) into the desired order.
- 8 Complete the setting by pressing the button **[MENU]** twice.
If you wish to change the basic setting, read the detailed notes in the section "Manual search".

Note:

* You can insert "new" TV channels into the "TV CHANNEL LIST" at a later date. For this, press the **[SELECT]** button in step 6. Several horizontal lines will appear to the right of the channel number. The "new" channel line is inserted and the following lines are shifted one position down. Press the **[▶]** button. The OSD page, e.g. "CHANGE TV CHANNEL P06", appears on the screen. Enter the data for the new TV channel. Confirm the entry by pressing the **[OK]** button. Complete the setting by pressing the **[MENU]** button twice.

4. PLAYING A RECORDED CASSETTE

In chapter 2, you have learned how to connect the video recorder to the TV set. When this is done, playback of a cassette is very easy. If you wish to record at first, go to chapter 5.

- 1 Switch the video recorder and the TV set on.

When starting play on the video recorder, many TV sets **switch automatically** to the programme position prepared for video playback.

With the "Easy Link" function, your TV set is even automatically switched on from standby.

But this will only function if the video recorder is connected via a Scart cable to the TV.

Otherwise, select the programme position intended for video playback on the TV set.

- 2 Insert the cassette into the cassette compartment.

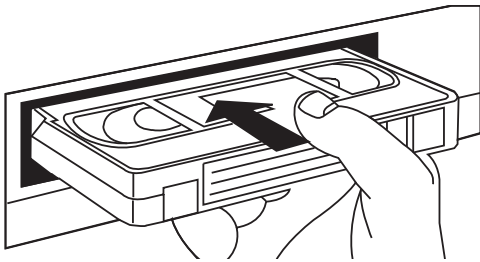

- 3 Press the **PLAY ▶** button. The display indicates "▶".
- 4 If you wish to stop play, press the **STOP ■** button. The display indicates "II".
- 5 To remove the cassette, press the **▲** button on the video recorder.

S-VHS or VHS Playback

The video recorder automatically recognises the correct cassette format (VHS or S-VHS) during playback.

When S-VHS recordings are played back, the symbol "S-VHS" will appear in the display.

Notes:

* Some functions are switched off automatically after a certain time (e.g., pause, slow motion, still picture, picture search). This is to avoid unnecessary cassette wear and energy consumption.

* It is possible to play on this video recorder cassettes which have been recorded in NTSC standard on other video recorders. In this case, the indication of the tape position is not possible.

Fast forward wind and rewind

- 1 Press the **STOP ■** button. Press the **◀◀** button (rewind) or **▶▶** button (wind). The tape is wound at fast speed in the corresponding direction.
- 2 Press the **STOP ■** button as soon as the desired tape position is reached.

Instant view

The "INSTANT VIEW" function allows you to switch to picture search while (re)winding.

- 1 Switch to picture search by keeping the button **INSTANT VIEW** pressed while (re)winding.
- 2 As soon as the button **INSTANT VIEW** is released, the video recorder switches back automatically to (re)wind.

Picture search

It is possible to select between two speeds for the forward and reverse picture search.

- 1 Press the **PLAY ▶** button.
- 2 Repeatedly press on the **◀◀** or **▶▶** button until the desired speed is obtained.
- 3 Press the **PLAY ▶** button as soon as the desired tape position is found.

Note:

* During the picture search (scan) function, the picture quality is adversely affected and the sound is muted.

Still picture/super slow motion

- 1 Press the **PLAY ▶** button.
- 2 Press the **STILL / JOG ON ▶◀** button. The picture "freezes" and the display indicates "▶◀". Each time you press the **STILL / JOG ON ▶◀** button, the still picture advances one step.

Press and hold down the **STILL / JOG ON ▶◀** button. The video recorder switches to super slow motion.

- 3 Press the **PLAY ▶** button to return to normal play.

Slow motion

- 1 Press the **STILL / JOG ON ▶◀** button. The video recorder switches to still picture mode.
- 2 Press the **▶▶** button repeatedly. The display indicates "▶▶". Three slow motions speeds can be selected: 1/7, 1/10, 1/14 of the normal playback speed. When you press the **◀◀** button several times, you will return to the still picture. If the button is pressed again, the slow motion function is reversed. The screen display will show: "◀◀". During slow motion, the sound is muted.
- 3 Press the **PLAY ▶** button to return to normal play.

Adjusting the picture sharpness

It is possible to adjust the picture sharpness during playback.

- 1 During playback, press the **▼** or **▲** button to change the setting in the range from "3" to "-3" ("3" is the maximum sharpness).

The JOG/SHUTTLE functions

There is a large rotary knob  both on the remote control and on the video recorder.

- 1 Switch the function on by pressing the **JOG SHUTTLE / STILL** button. A still picture is visible on the screen.

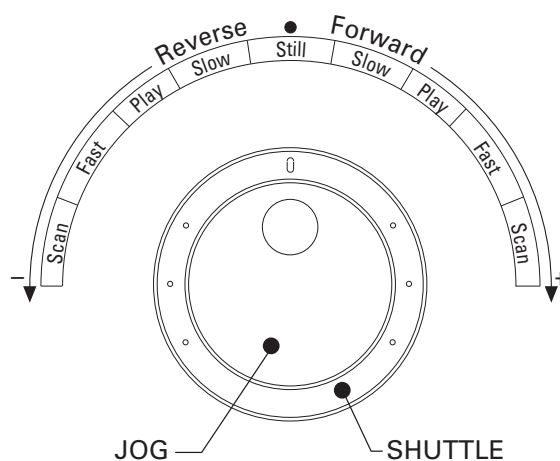

- 2 Use the inner disk to select the next or previous still picture.
- 3 Turn the inner disk continuously to the right **or** to the left switches to super slow motion, forward or reverse.
- 4 The outer ring enables you to select different tape speeds for the forward or reverse picture search.
- 5 Press the **PLAY ▶** button to return to normal play.

Note:
* During the picture search (scan) function, the picture quality is adversely affected and the sound is muted.

Correcting picture interference. The cleaning function

Each time you start a new playback, the video recorder automatically adjusts the correct tracking for the cassette.

For cassettes recorded on another recorder, it is possible to improve the automatically made optimum adjustment as follows.

- 1 During playback or still picture mode, press the **MENU** button.
- 2 Select the menu line "Picture". Confirm with the **▶** button.
- 3 The "PICTURE" menu appears on the screen. The option "Tracking" (on playback) **or** "Vertical jitter" (still picture) is highlighted.

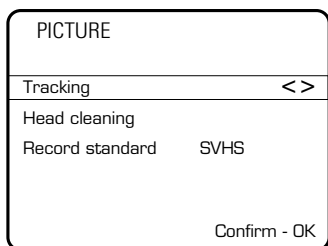

- 4 Press the **◀** or **▶** button until the best picture quality is obtained.

If horizontal interference bars cannot be removed, proceed as follows:

- 5 Select the menu item "Head cleaning". Press the **▶** button.
The video heads are cleaned.
- 6 Save the setting with the **OK** button.
- 7 Terminate the adjustment with the **MENU** button.

Note:

* When using cassettes of bad quality, it is possible that interferences may occur.

Selecting the audio track, audio-mix

You can select the audio track you want to hear during playback or in tuner mode. This is especially useful for two-channel sound (multi-language) transmissions.

- 1 Press the **SELECT** button. The display indicates the current setting. If you press the **SELECT** button repeatedly, you can select between four possibilities (STEREO, LEFT, RIGHT, MONO).

Notes:

* During playback, you can select a further possibility, the "MIXMODE" function.

With this function, you will hear the mono sound of the normal (linear) track together with the sound of the stereo track. This enables you to play recordings which have been dubbed.

* If no stereo sound is recorded on the cassette, the video recorder switches automatically to mono sound.

Surround-sound playback

If your TV set or hifi equipment is suited for surround-sound play, the video recordings will be played back with this audio system.

How do I know where I am currently on the tape?

The length of the tape is indicated in minutes on the cassette, e.g. "E180" corresponds to 180 minutes playing time (= 3:00 hrs).

The length indication is found on the front narrow side of the cassette to the left. The actual playing time may be slightly longer than indicated (e.g. 3:05 hrs).

- 1 Start the tape measurement function with the **COUNTER** button on the remote control. The video recorder's display indicates "WAIT".

Then the video recorder switches, for example, to "STOP".

The video recorder's display indicates, for example, "P03 2:20"

- 2 With the **COUNTER** button, you can select between the following indications:
 - elapsed playing time e.g. 0:40
 - remaining playing time e.g. L 2:20 ("L" = TIME LEFT) real time counter e.g. 0:1:45 (in hrs/min/sec).

Notes:

- * When a cassette is inserted, the video recorder must at first calculate the playing time. That is why the display indicates at first " - : - - " and only after several seconds tape run the playing time.
- * You can set the tape counter manually to "0". Use the **COUNTER** button to select the counter mode, then press the **CLEAR** button.
- * If a minus sign appears in front of the real time counter (e.g., "- 0:20:00"), the tape is not wound to its beginning.
- * The indications can be read off exactly to the minute during recording, playback and pause/stop.

Index search

The video recorder writes a mark on the tape every time a recording is started. With the **INDEX**, **INDEX**, **INDEX** buttons on the remote control you can find these marks on the tape.

- 1 Press the **INDEX** and **INDEX** buttons to find the next mark and the **INDEX** and **INDEX** buttons to find the previous mark. The video recorder's display indicates "INDEX".
- 2 As soon as the mark is found, the video recorder switches automatically to playback.

Intro-scan



- 1 Press the **INDEX** and **PLAY** buttons. The video recorder's display indicates "INTRO".
- 2 The tape is wound to the next mark, played back for 10 seconds, then wound to the next mark and played back for 10 seconds, and so on. When the end of the tape is reached, the tape is automatically rewound to the beginning.

Notes:

- * If you press any tape run button (e.g. **PLAY** or **STOP**) during the index search or intro-scan function, the video recorder interrupts this function.
- * For recordings made without marks on another video recorder, the index search and intro-scan functions cannot be used.

5. HOW CAN I RECORD DIRECTLY ?

If you wish to record, proceed as follows:

- 1 Switch the video recorder on.
Insert a cassette not protected against recording.
- 2 Use the  or  button to select the programme position from which you wish to record, e.g. "P01".

Note on TV sets with "Easy Link" function:



* The video recorder will **always** record the TV programme currently selected on the TV set. You can switch off the TV set, switch it on again or change the programme without affecting the recording.

- 3 Press the  button to start recording.

The video recorder's display indicates "●" and the video recorder records the desired TV programme.

- 4 Press the  button to terminate recording.

Note:

* If you do not wish to record till the end of the cassette, press the  button a second time. The display then indicates the time when the recording will end. Each further pressure on the  button increases the end time in steps of 30 minutes.

If you have pressed too often, press the  button to return to the normal recording mode. When the end time is reached, the video recorder switches automatically off.

General notes:

* If recording on a S-VHS cassette should only be made in VHS standard, then press the  button on the remote control **before recording**

The OSD page "MAIN MENU" appears on the screen. Select the line "Record mode".



Confirm with the  button. Select the line "Record standard".

Select the "VHS" recording standard.

* The programme positions "E1", "E2", "E3" and "E4" are intended for recordings from external video/audio sources via the sockets

 **1 EXTERNAL / EURO-AV 1**,

 **2 EXTERNAL / DEC.-AV 2**,  ("E3") or

 **S VHS** ("E4") and  +  (audio input sockets for "E3" and "E4").

* Do you wish to change to another TV programme during recording and record this?

Interrupt the current recording with the  button.

Select the new programme number and start the recording with the  button.



* If a cassette protected is loaded, the video recorder switches automatically to "PLAYBACK".

* If the tape end is reached during recording, the cassette is automatically ejected and the recorder switches off after a few minutes.

* When making a new recording, the existing recordings on the cassette are automatically erased.

Assembly editing

This function serves for joining single recordings or scenes without disturbing transitions.

- 1 Press the  button. Search for the correct position on the tape and then stop playback with the  button. "II" appears in the display.
- 2 Now begin recording as usual with the  button.

Direct recording with TV sets without "Easy Link" function

If you wish to record a TV programme you are watching, press the button **RECORD** on the video recorder when the VCR is **switched-off**.

The video recorder "calls up" the current programme position number from the TV set via the Scart cable and starts recording.

Notes:

- * In order for "Direct Record" to function, it must be switched to "on" as described in Chapter 8 in the section entitled "Personal preferences" .
- * The video recorder must be connected via a Scart cable to an appropriate TV set.
- * Not all external units (e.g. certain satellite receivers, Pay-TV decoders) are appropriate for the "Direct recording" function.
- * Select another programme number on the TV set not until "READY" appears in the video recorder's display.

Erase protection

So that you don't accidentally delete an important recording, you can remove the special tab (erase protection) on the front of the cassette with a screwdriver or slide it to the **left**.

Later, if you no longer want the erase protection, you can seal the gap once more with adhesive tape or slide the tab to the **right**.

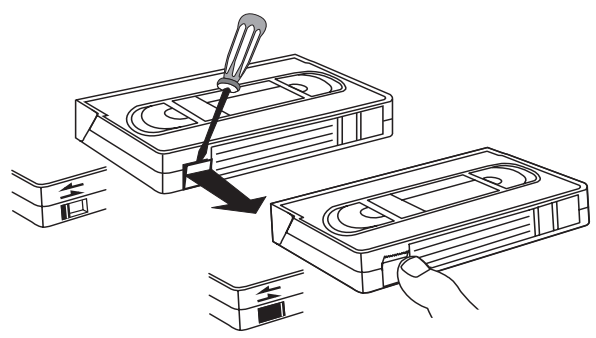

Longplay function

You can reduce the recording speed by half. This makes it possible to record, for example, 8 hours instead of 4 hours with an "E240" cassette.

- 1 To do this, you must select "LP" for the tape speed in paragraph "Personal preferences" in chapter 8. The video recorder's display indicates "LP".
- 2 When starting playback, the video recorder will automatically select the correct tape speed.

Notes:

- * You will get the best picture and sound quality if you record with standard speed ("SP").
- * During picture search, still picture, super slow motion and slow motion, playback is not in colour.

HiFi stereo reception

This video recorder can record and play back stereo broadcasts. Playback then is in HiFi quality.

6. HOW DO I PROGRAMME A RECORDING?

In this chapter you will learn how to programme the video recorder. It switches itself on automatically, records the TV programme you want, and then switches itself off again automatically.

What information is required by the video recorder?

For every programmed recording, you must give the video recorder the following information:

- * the date on which the recording is to be made
- * the programme number for the TV programme
- * the start time of the recording
- * the end time of the recording
- * VPS/PDC on or off

If you use "Programming with ShowView", you need **only** enter the ShowView code. This code contains the complete information the recorder needs. The "ShowView guide numbers" are **automatically** allocated on this video recorder.

SHOWVIEW

The video recorder stores all of the information it requires for recording in what is known as a TIMER block. It can store this information up to four weeks in advance.

Your video recorder can store up to 6 of these TIMER blocks.

Make sure that the times of the TIMER blocks do not overlap. The video recorder first must finish one TIMER block before starting the next block.

What is "PDC"(Programme Delivery Control) and "VPS" (Video Programme System) ?

With VPS and PDC, the TV station controls when the video recorder is switched on and off. This means that the video recorder switches itself on and off at the **right time** even if a TV programme you have programmed begins earlier or finishes later than expected. You can see if a TV station is transmitting a VPS or PDC code if "VPS" or "PDC" appears in the display on the video recorder when the recorder is switched to "STOP".

If you wish to use VPS/PDC, the "VPS/PDC" indication must be switched **on** in the following paragraph. If you do not wish to use VPS/PDC, the "VPS/PDC" indication must be switched **off**.

Notes:

- * With VPS/PDC, two subsequent TV broadcasts on the same programme position can only be programmed as two separate TIMER blocks.
- * The first few seconds of a programme intended for recording will be missing if the switch-on command transmitted by the TV station is late.
- * VPS/PDC only works as it should if television reception is good. If reception conditions are less than optimum (e.g. if you use a room aerial), VPS/PDC may not function as it should; this does not indicate that your video recorder is not functioning properly.

Programming with "ShowView"

This method makes programming your video recorder as easy as dialing a telephone number. All you need to do is enter the (three- to nine-digit) ShowView code which is printed in your TV guide next to the starting time for the TV programme.

You can programme with the buttons on the video recorder and/or on the remote control handset. Be sure you have inserted a cassette without erase protection.

- 1 Switch on the TV set and select the programme position intended for the video recorder.
- 2 Press the **TIMER** button on the remote control. The OSD page "TIMER" appears on the picture screen.
- 3 Select the option "ShowView". Confirm with the **▶** button.
- 4 The OSD page "SHOWVIEW" appears on the picture screen.

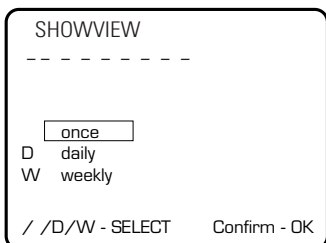

- 5 Enter the ShowView code with the numeric buttons **0-9**. If you make a mistake, use the **CLEAR** button to correct it.
- 6 If you wish to programme daily or weekly recordings, use the **SELECT** button to select the "daily" or "weekly" option. Daily recordings can be programmed only for the weekdays Monday through Friday.
- 7 Press the **OK** button. The programmed code now is deciphered. After the code has been deciphered correctly, the corresponding information appears on the picture screen and in the display on the video recorder.

Notes:

- * When programming with ShowView for the **first time**, the programme position "E 2" is used. On the picture screen appears the message "Please enter programme number". Use the **▼** or **▲** button to select the "correct" programme position number (e.g. "Prog 01" for "ARD"). Confirm with the **OK** button. The video recorder will use this programme number for all future ShowView programmings for this TV channel.
- * The "VPS/PDC" function can be switched on and off with the **SELECT** button. Press the **▶** button
- * If you wish that "subtitles" are also recorded, press the **SELECT** button. Enter the number of the subtitles page as **three digits** with the numeric buttons **0-9**.

- 8 Have you entered all the data correctly? If you have, press the **OK** button. "Timer ready" appears briefly in the screen display.

The symbol "⏸" appears in the video recorder's display. It indicates that a TIMER has been programmed.

- 9 Terminate programming with the **STANDBY** button.

Some important information:

- * If you wish to use the programme number "E2" in order to record from an external source (e.g. from a satellite receiver), confirm the programme number "E2" indicated in Step 7 by pressing the button **OK**.
- * If "CODE ERR" appears in the display, the numerical code is wrong or has been entered wrongly. Repeat the entry or terminate by pressing the button **STANDBY**.
- * If "SET CLOCK" appears in the display, the internal clock of the video recorder has not been set. Set the clock.
- * Daily recordings can only be programmed for the weekdays Monday to Friday.
- * In the case of "daily/weekly" programming, the first recording must be made within the first week.
- * Some TV programmes go on for longer than advertised. If you wish to enter a later end time, select "End" using the button **▶** in Step 7 and enter the end time using the button **▼** or **▲** or the digit buttons **0-9**.
- * The "SHOWVIEW" menu appears straight after Step 2 if you have set the display "ShowView" on the OSD page "PERSONAL PREFERENCES". (See Step 5 of the section "Personal preferences" in Chapter 8).

Programming with TXT pages

With the help of the remote control handset, the on-screen user's guide and the page memory, TIMER programming is considerably facilitated. The general use of the TXT decoder is to be found in the chapter "Additional functions" later in this booklet.

You can programme with the buttons on the video recorder and/or on the remote control handset. Be sure you have inserted a cassette without erase protection.

- 1 Switch on the TV set and select the programme position intended for the video recorder.
- 2 On the video recorder, select the TV programme position from which you wish to make TIMER recordings.
- 3 Press the **MENU** button.
- 4 Select the option "Easy Textprogramming". Confirm with the **▶** button.
- 5 The OSD page "EASY TEXTPROGRAMMING" appears on the picture screen. The last selected programme position (e.g. "01 ARD") and a page number (e.g. "301") are highlighted.

EASY TEXTPROGRAMMING				
Programme	Page			
01 ARD	301	302	303	304
02 ZDF	100	100	100	100
03 RTL	100	100	100	100
04 SAT1	100	100	100	100

Select programme - A V
 Enter page - SELECT Textprog. - OK
 Select page - < > Exit - MENU

- 6 Select the programme position from which you wish to record. If necessary, select another page number.
- 7 Start TXT programming with the **OK** button. The TXT page appears on the picture screen. The starting time of the first TV programme is marked by a cursor **■**.
 If the cursor **■** does not appear (e.g. on subpages), press the **OK** button.
 If necessary, select another page number.

- 8 Select the desired TV programme.
 The cursor **■** marks the start time of the selected TV programme.
 - 9 Confirm with the **OK** button.
 The picture screen and the video recorder's display indicate the TIMER data.
 - 10 If you wish to programme daily or weekly recordings, select the line "daily" or "weekly" using the **SELECT** button.
 Either "D" or "W" also appears beside the date. Daily recordings can only be programmed for the weekdays Monday to Friday.
 - 11 Press the **▶** button.
 If you wish that "subtitles" are also recorded, press the **SELECT** button. Enter the number of the subtitles page as **three digits** with the numeric buttons **0-9**.
 - 12 Confirm with the **OK** button.
 "Timer ready" appears briefly in the screen display.
- If you wish to programme further recordings, restart with step 6.
- 13 Terminate programming with the **STANDBY** button. The symbol "⏻" appears in the video recorder display. It indicates that a TIMER has been programmed.

Notes:

- * If "SET CLOCK" appears in the display, the internal clock of the video recorder is not set. Set the clock.
- * If "DAILY ERR" appears in the display, you have programmed a TV programme with the **first** recording on a Saturday or Sunday as "daily". This is not possible.
- * Daily recordings can only be programmed for the weekdays Monday to Friday.
- * For "daily/weekly" programming, the first recording must be scheduled within one week.

TIMER Programming (Standard Timer)

Data on **six** recordings can be entered and stored in the video recorder. The OSD page on screen or the video recorder display will lead you "step by step" to the next and possible data entry.
The data is stored in the next free TIMER block of the video recorder.

You can programme with the buttons on the video recorder and/or on the remote control handset. Ensure that a cassette without erase protection is inserted.

- 1 Switch on the TV set and select the programme number for the video recorder.
- 2 Press the remote control button **TIMER**. The OSD page "TIMER" appears on screen.
- 3 Select the line "Standard Timer". Confirm this by pressing the button **▶**.
- 4 The OSD page "TIMER" appears on screen. The following appears in the insert line: "today's" date, the current time as a start time and the current time plus "1:30 hours" as an end time.

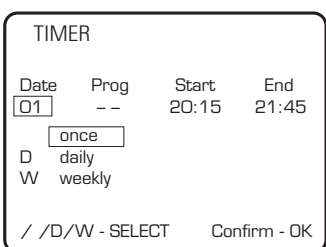

- 5 If you wish to programme daily or weekly recordings, select the line "daily" or "weekly" using the button **SELECT**. Either "D" or "W" also appears beside the date. Daily recordings can only be programmed for the weekdays Monday to Friday.
- 6 Enter the data using the digit buttons **0-9**, or confirm the date by pressing the button **▶**.

- 7 If you wish that "subtitles" are also recorded, press the **SELECT** button. Enter the number of the subtitles page as **three digits** with the numeric buttons **0-9**.
- 8 Enter the number of the TV programme using the digit buttons **0-9**.
- 9 The "VPS/PDC" function can be switched off and back on again by pressing the button **SELECT**.
- 10 Enter the start time using the digit buttons **0-9**.
- 11 Enter the end time where necessary.
- 12 When you have entered **all** data correctly, press the button **OK**. "Timer ready" appears briefly in the screen display.

The symbol "Ⓢ" appears in the video recorder display. It indicates that a TIMER has been programmed.

If you wish to programme additional settings, repeat Steps **2** – **12**.

- 13 Terminate programming with the **STANDBY** button.

Some important information:

- * If "SET CLOCK" appears in the display, the internal clock of the video recorder has not been set. Set the clock.
- * Daily recordings can only be programmed for the weekdays Monday to Friday.
- * In the case of "daily/weekly" programming, the first recording must take place within the first week.
- * The "TIMER" menu appears straight after Step **2** if you have set the display "Standard Timer" on the OSD page "PERSONAL PREFERENCES". (See Step **5** of the section "Personal preferences" in Chapter 8).

How can I record from a satellite receiver?

It is also possible to programme recordings from an external satellite receiver.

- 1 Connect the satellite receiver with the socket **DEC.-AV 2**. Make sure that the satellite receiver is switched on and tuned to the desired satellite station.
- 2 Programme a TIMER block using one of the already described methods. Select the programme position "E2" for the external programme source (satellite receiver).

Note:

* If you use "Programming with ShowView" for the Timer recording from the "external" satellite receiver, the video recorder selects automatically the programme position "E2". In this case, you can ignore the message "Please enter programme number".

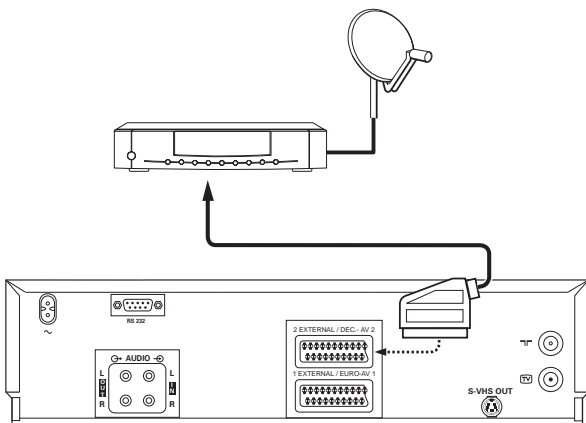

A few general notes on programming

- The programmed recording will always be effected with the recording speed (SP or LP) selected in the OSD page "PERSONAL PREFERENCES".
- If you have forgotten to insert a cassette before programming, the recorder's display indicates "NO CASS".
- If you insert a cassette with erase protection for the recording, the indication "PROTECTED" briefly appears in the video recorder's display after you have finished programming. The cassette is then ejected.
- TIMER recording is only possible if the video recorder is **switched off**. If the video recorder is switched on before a programmed recording, the message "TIMER REC" flashes in the display.
- If the recording times of the TIMER blocks overlap each other, the message "COLLISION" appears in the video recorder's display. In this case, you must correct or clear the data of one TIMER block. How this is done is explained in the paragraphs "How can I check, clear or correct a TIMER block?"
- If you have programmed all TIMER blocks, the message "FULL" appears in the video recorder's display. Refer to the paragraphs "How can I check, clear or correct a TIMER block?"
- If the end of the cassette is reached during a TIMER recording, the recorder ejects the cassette. The video recorder's display indicates "TIMER REC". Insert a "new" cassette into the video recorder then press the **STANDBY** button on the remote control to resume the TIMER recording.
- If TIMER recordings are programmed, the video recorder cannot be switched in the "save energy mode".

How do I stop a TIMER recording ?

While a programmed recording is running, the drive mechanism buttons of the video recorder are blocked. If you want to stop the running recording, press the **STANDBY** button.

How can I check a TIMER block ?

- 1 Switch on the TV set and select the programme position intended for the video recorder.
- 2 Press the **MENU** button. The OSD page "MAIN MENU" appears on the picture screen.
- 3 Select the option "Timer list". Confirm with the **▶** button.
- 4 The OSD page "TIMER LIST" appears on the picture screen.

Check all of the TIMER data. If the data is correct, press the **STANDBY** button to terminate.

How can I clear or correct a TIMER block ?

- 1 Switch on the TV set and select the programme position intended for the video recorder.
- 2 Press the **MENU** button on the remote control. The OSD page "MAIN MENU" appears on the picture screen.
- 3 Select the option "Timer list". Confirm with the **▶** button.
- 4 The OSD page "TIMER LIST" appears on the picture screen.

- 5 Do you wish to clear a TIMER block?
If yes, select the desired line (TIMER block) with the **▼** or **▲** button. Press the **CLEAR** button to clear the TIMER block.

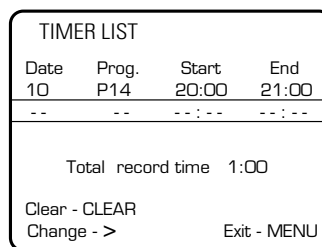

- 6 Do you wish to correct a TIMER block?
If yes, select the desired line (TIMER block) with the **▼** or **▲** button. Press the **▶** button.
- 7 The OSD page "TIMER" appears on the picture screen.
Use the **◀** or **▶** button to select the TIMER-data (Dat., Prog., Start or End) you wish to correct.

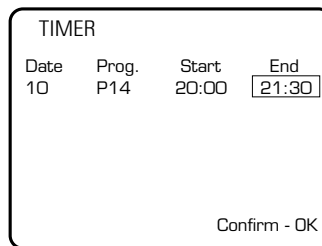

- 8 Correct the data with the numeric buttons **0-9** or with the **▼** or **▲** button.
- 9 Have you entered all data correctly?
If yes, press the **OK** button on the remote control.
"Timer ready" appears briefly in the screen display and is followed by the OSD page "MAIN MENU".
- 10 Terminate programming with the **MENU** or **STANDBY** button.

Sorting TV programmes for TIMER programming

Do you prefer certain TV programmes for TIMER recording?

With the Sort function, you can create a separate programme list to your preferences.

Note:

* The programme order stored in the video recorder is **not changed**. Only the TV programmes in the OSD page "EASY TEXTPROGRAMMING" are brought in a new order.

- 1 Switch on the TV set and select the programme position intended for the video recorder.
- 2 Press the **MENU** button. The OSD page "MAIN MENU" appears on the picture screen.
- 3 Select the option "Easy Textprogramming". Confirm with the **▶** button.
- 4 The OSD page "EASY TEXTPROGRAMMING" appears on the picture screen. A page number of the last selected programme number is highlighted. Use the **◀** button to select the programme number. The programme number and the programme name are highlighted.
- 5 Select your favourite TV programme from which you wish to make most of your TIMER recordings.
- 6 Press the **SELECT** button. The programme name disappears and two horizontal lines appear in the place of the programme number.

EASY TEXTPROGRAMMING				
Programme	Page			
14 ARTE	100	100	100	100
15 CNN	100	100	100	100
--	100	100	100	100
17 ZDF	301	302	303	304
18 PREM	100	100	100	100
Enter programme - 0 - 9				
Exit - MENU				

- 7 Enter the programme number "01" as **two digits** with the numeric buttons **[0-9]**. After the entry of the second digit, the two TV programmes are exchanged.
- 8 Select the TV programme you wish to appear at the second position in the list.

Repeat the steps 5 to 7 until your favourite TV programmes are in the desired order.

EASY TEXTPROGRAMMING				
Programme	Page			
01 ARD	100	100	100	100
02 ZDF	100	100	100	100
03 RTL	100	100	100	100
04 SAT1	100	100	100	100
Select programme - ^ V				
Enter page - SELECT		Textprog. - OK		
Select page - < >		Exit - MENU		

- 9 Complete the setting by pressing the button **MENU** twice.

7. EDITING VIDEO RECORDINGS

It is not possible to simply cut video tapes with a pair of scissors then splice them.

If you wish to join and/or insert new scenes without disturbing transitions and exactly to the picture into existing recordings, it is necessary to use an electronic cutting facility when copying from one video tape to another.

This creation of "new" video recordings is called "editing". For editing, different methods can be used.

Audio dubbing

This means that an appropriate sound is added to an existing video recording.

With this function, it is possible to **replace** the mono sound track on the video tape with another sound. The old mono track is completely erased. The stereo sound track and the video recording remain unchanged.

The insert and insert-edit functions

With the insert functions, it is possible to conveniently insert other picture and/or sound recordings into existing recordings **without disturbing transitions**. You have the choice between three insert functions.

Synchronous editing (synchro-edit)

When copying between this video recorder and a second video recorder or camcorder being correspondingly equipped, this function provides for a synchronous start of both units.

This ensures that every scene will be copied **exactly to the picture** and **without disturbing transitions**.

The programme edit functions

You can mark up to ten (10) individual scenes from existing video recordings, transfer to the "Programme Edit" list of the video recorder, rearrange and afterwards re-record one after the other onto a video cassette.

It is a prerequisite that your camcorder is equipped with a "Bus control" and has an hour, minute, second or single picture counter (time code counter).

Audio Dubbing

It is possible to dub (overscore) another sound recording onto the audio track of an existing recording at a later date.

To do this connect a sound source (e.g. CD player) to the **[L]** + **[R]** input sockets or a microphone to the **[MIC.]** socket. The sockets are at the front of the video recorder behind a flap.

Insert the recorded cassette into the video recorder. Make sure the cassette is not protected against recording!

- 1 Press the **[MENU]** button. Select the "A/V Edit" line. Confirm with the **[▶]** button.
- 2 The OSD page "EDIT MENU" will appear on the screen. Select the line "Audio dubbing". Confirm with the **[▶]** button.
- 3 The OSD page "AUDIO DUBBING" will appear on the screen.
If you want to fade the sound in or out, select the corresponding line "Fade in" or "Fade out". Switch to "on" with the **[▶]** button. Select the line "Start dubbing". Confirm with the **[▶]** button.
- 4 Find the position where you want the recording to end in playback mode.
End the search with the **[STILL / JOG ON ▶◀]** button. Set the display to "0:00:00" (= Edit out) with the **[EDIT OUT]** button.
- 5 Using reverse picture search find the position where audio dubbing is to start.
- 6 Press the **[STOP ■]** button.
- 7 Switch the sound source on.
Use the slider control **[L RECORD LEVEL R]** or **[MIC. - ▲ +]** on the video recorder to adjust the recording level so that the "0 dB" mark lights up during the loudest passages of the recording.

-
- 8 Start dubbing with the **RECORD ●** button at the right time.

The video recorder will start to record the sound from the sound source. The audio track will be re-recorded. It is possible to monitor the sound recording via a headphone connected to the **Ω** socket.

Adjust the volume level of the headphone with the slider control **Ω - ▴ +** on the video recorder.

The audio recording **stops automatically** when the display counter reaches "0:00:00" (=Edit out).

- 9 If you want to abort, then press the **STOP ■** button.
- 10 End audio dubbing with the **MENU** or **STANDBY ◊** button (remote control).

Notes:

* To play back the audio dubbing sound press the **SELECT** button repeatedly until "MONO" appears in the video recorder's display.

* If you connect an audio mixer to the video recorder, you can mix the original hifi sound on the video cassette with the sound from several external sound sources. The original hifi sound can be taken from the **AUDIO L OUT R** Cinch sockets (at the rear of the video recorder) and passed to the audio mixer.

Connect the audio mixer to the Cinch sockets **L + R** (front of video recorder).

Start playback on the video recorder.

Use the slider controls **L RECORD LEVEL R** to adjust the recording level from the audio mixer so that the "0 dB" mark lights up during the loudest passages of the recording.

* To hear the dubbed sound, you must select the Mono track for playback.

The insert functions

With the insert functions, it is possible to conveniently insert other picture and/or sound recordings into existing recordings.

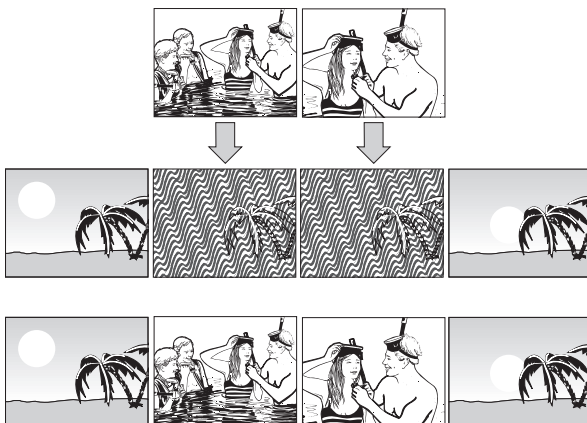

Connect the video/audio source to the input sockets **V** ("E3") or **S VHS** ("E4") and **L** + **R** (audio input sockets for "E3" and "E4") of the video recorder. The sockets are located behind the flap at the front of the recorder, **or**

connect the video/audio source to the Scart sockets **EURO-AV 1** or **DEC-AV 2** of the video recorder. The sockets are located on the back of the video recorder.

You have the choice between three insert functions.

- "INSERT DUBBING": the picture, the hifi sound (helical track), and the mono sound (longitudinal track) are newly recorded.
- "INSERT VIDEO": the picture and the hifi sound (helical track) are newly recorded, the mono sound (longitudinal track) is maintained.
- "INSERT COPY": the picture is newly recorded. The mono sound (longitudinal track) is retained and transferred onto the hifi track (helical track).

Please also see the operating instructions of the connected unit.

Insert the recorded cassette into the video recorder. Make sure the cassette is not protected against recording!

- 1 Switch on the TV set and select the programme position intended for the video recorder.
- 2 Switch the video recorder on.

- 3 Search the desired end of the insert recording on the cassette in the video recorder. Press the **STOP** button. Use the **COUNTER** button to select the counter mode. Press the **CLEAR** button to reset the tape counter to "0:00:00".
- 4 Search the desired beginning of the insert recording on the cassette in the video recorder. Press the **STOP** button.
- 5 Switch on the external video/audio source. Search the beginning of the insert recording.
- 6 Press the **MENU** button. Select the option "Record modes". Confirm with the **▶** button. The OSD page "RECORD MODES" appears on the picture screen. If the picture/sound source is connected to the input sockets **V** ('E3') **or** **S VHS** ('E4') and **L** + **R** (audio input for "E3" and "E4"): Use the slider controls **L RECORD LEVEL R** to adjust the recording level so that the "0 dB" mark lights up during the loudest passages of the recording.

If the picture/sound source is connected to the **EURO-AV 1** **or** **DEC-AV 2** socket, the recording level is adjusted automatically.

- 7 Select the desired insert function: "Insert Dubbing" **or** "Insert Video" **or** "Insert Copy". Select the programme position for the connected video/audio source ("E1", "E2", "E3" or "E4").

Follow the user guide on the OSD page.

- 8 Start the insert recording at the "correct" moment with the **RECORD** button.
- 9 The insert recording is **automatically stopped** when the tape counter has reached "0:00:00".
- 10 Press the **MENU** button or the **STANDBY** button (remote control) to terminate the recording.

Note on "INSERT VIDEO":

* To start playback of the "original" sound, repeatedly press the **SELECT** button on the remote control until the video recorder's display indicates "MONO".

Adjusting the video recorder (VCR) to the camcorder (CC) (edit-setup)

You can synchronously copy between this video recorder (VCR) and an appropriately equipped camcorder (CC). Both units are started at the same time with the help of a synchronous impulse and an adjustable start delay (= preroll time). Various operating and cabling variants are possible. You will find an overview of the synchro-edit cables at the end of this operating manual.

Connect the two units with the corresponding synchro-edit cable (socket **SYNCHRO EDIT** or **MEI EDIT** on your video recorder).

Connect the video/audio source to the input sockets **V** ("E3") or **S VHS** ("E4") and **L** + **R** (audio input sockets for "E3" and "E4") of the video recorder. The sockets are to be found behind the flap at the front of the recorder.

Please also observe the operating instructions of the camcorder.

Insert a cassette without erase protection into the video recorder

- 1 Switch on the TV set and select the programme position intended for the video recorder.
- 2 Switch the video recorder on. Select the programme position "E3" or "E4".
- 3 Press the **MENU** button. The OSD page "MAIN MENU" appears on the picture screen. Select the menu option "A/V Edit". Confirm with the **▶** button.
- 4 The OSD page "EDIT MENU" appears on the picture screen; the option "Edit Setup" is highlighted. Confirm with the **▶** button.

Follow the user guide on the OSD page.

- 5 Switch the **camcorder** to **still picture** (playback-pause).
- 6 Press the **OK** button on the video recorder's remote control. Wait until the video recorder has recognized the connected camcorder.

Follow the user guide on the OSD page.

- 7 You can call up the default start delay (= preroll time) for the connected camcorder type by pressing the **CLEAR** button. It is then possible to alter the preroll time with the **◀** or **▶** button. Press the **▼** button.
- 8 Select the desired insert edit function: "Insert Dubbing" **or** "Insert Video" **or** "Insert Copy".
- 9 Confirm with the **MENU** button.

Note:

* The start delay (= preroll time) must be adjusted only once. The video recorder will save this setting. Keep in mind that other camcorder types must also be adjusted when being used the first time.

Synchronous editing (synchro-edit)

- 1 Call up the OSD page "EDIT MENU". Use the **▼** button to select the option "Synchro Edit". Confirm with the **▶** button.
- 2 The OSD page "SYNCHRO EDIT" corresponding to the connected camcorder type appears on the picture screen.
- 3 Use the **RECORDER** button to select the OSD page "Recorder" (for **video recorder** mode). Search the beginning of the recording on the video recorder. Switch the video recorder to playback-pause.
- 4 Use the **PLAYER** button to select the OSD page "Player" (for **camcorder** mode). Search the beginning of the recording on the camcorder. Use the slider controls **L RECORD LEVEL R** to adjust the recording level so that the "0 dB" mark lights up during the loudest passages of the recording. Switch the camcorder to still picture (playback-pause).

Follow the user guide on the OSD page.

The way copying is started depends on the camcorder and the corresponding synchro-edit cable used.

Variant 1 as shown in figure 1 or figure 2 if the video recorder is to control the camcorder.

- 5 Start copying with the **RECORD** button on the video recorder.
The camcorder starts with "PLAYBACK" and at the same time the video recorder starts with "RECORDING".
- 6 Stop copying with the **STOP** button on the video recorder.
- 7 End copying with the **MENU** button or the **STANDBY** button on the remote control.

Notes:
 * If the beginning of the scene is missing, the preroll time is too long. Set a shorter time.
 If recording is started too soon (before the scene to be copied), the preroll time is too short. In this case, the preroll time must be increased.
 * If your camcorder is equipped with a 2.5 mm ø control socket (LANC control) or a 5-pin MEI-socket, the playback and fast wind functions of many camcorders can be controlled with the corresponding control elements on the video recorder.

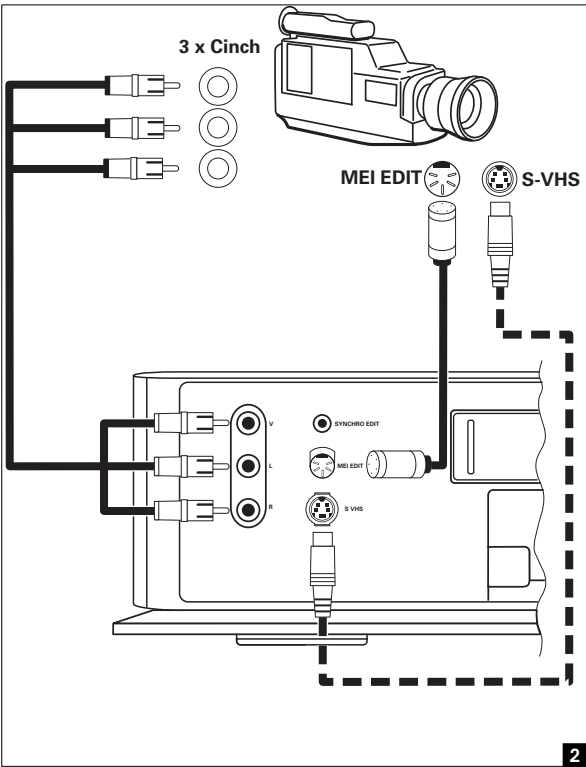
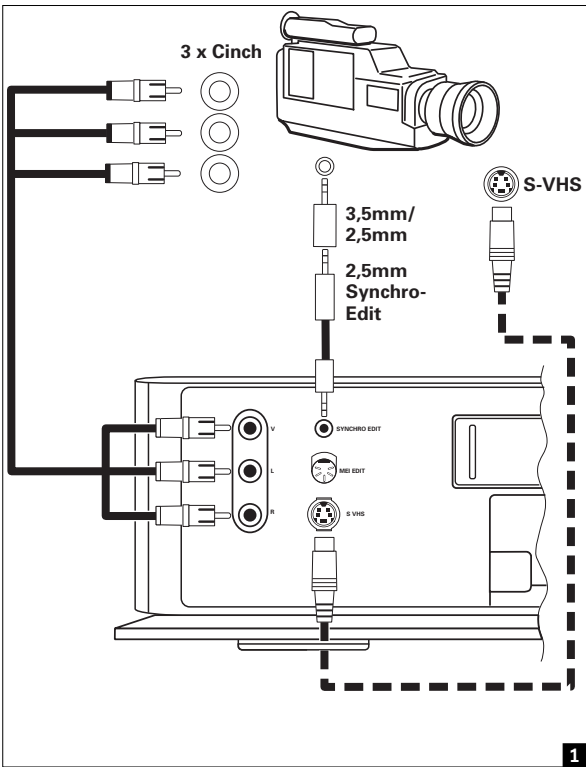

Variant 2 as shown in figure 3 or figure 4 if the camcorder is to control the video recorder.

- 5 Start copying with the corresponding button on the camcorder or its remote control.
The camcorder starts with "PLAYBACK" and at the same time the video recorder starts with "RECORDING".
- 6 Stop copying with the PAUSE or STILL button on the camcorder or on its remote control.
- 7 End copying with the **MENU** button or the **STANDBY** button on the remote control.

Notes:

* If the beginning of the scene is missing, the preroll time is too long. Set a shorter time.
If recording is started too soon (before the scene to be copied), the preroll time is too short. In this case, the preroll time must be increased.

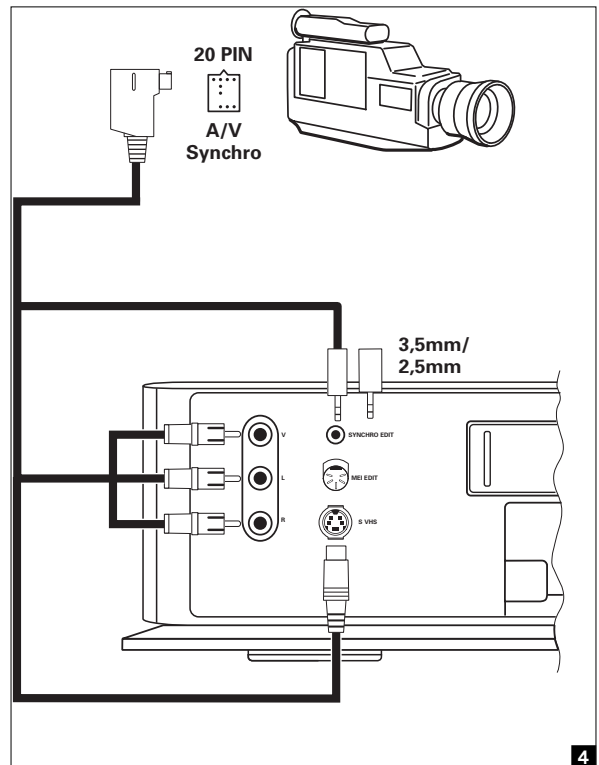
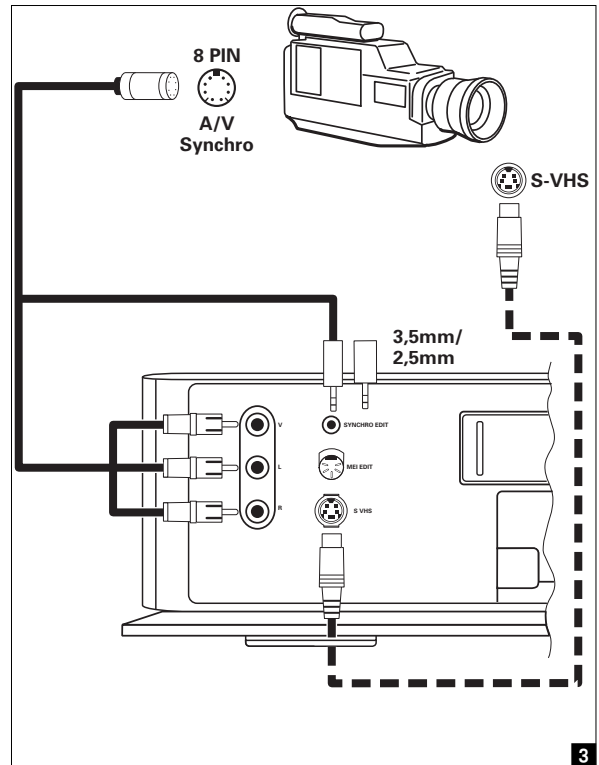

Insert-edit functions

With the insert-edit functions, it is possible to conveniently insert other picture and/or sound recordings into existing recordings.

Connect the two units with the corresponding synchro-edit cable (socket **SYNCHRO EDIT** or **MEI EDIT** on your video recorder).

Connect the video/audio source to the input sockets **V** ("E3") or **SVHS** ("E4") and **L** + **R** (audio input for "E3" and "E4") on the video recorder. The sockets are to be found behind the flap at the front of the recorder.

If your camcorder is equipped with a 2.5 mm ø control socket (LANC control) **or** a 5-pin MEI-socket, you have the choice between the following insert-edit methods:

- Method 1 "INSERT VCR": you mark on the cassette in the video recorder the tape position where the "new" recording is to **end**.
- Method 2 "INSERT CC": you mark on the cassette in the camcorder the **beginning** and the **end** of a "scene" (tape position) you wish to insert into an existing recording.
However, this works only if the camcorder is equipped with a 2.5 mm ø control socket (LANC control) **or** a 5-pin MEI-socket.

You have the choice between three insert-edit functions:

- "INSERT DUBBING": the picture, the hifi sound (helical track), and the mono sound (longitudinal track) are newly recorded.
- "INSERT VIDEO": the picture and the hifi sound (helical track) are newly recorded, the mono sound (longitudinal track) is maintained.
- "INSERT COPY": The picture is newly recorded. The mono sound (longitudinal track) is retained and transferred onto the hifi track (helical track).

Note:

* The video recorder will always use that insert function you have selected in the paragraph "Adjusting the video recorder to the camcorder".

Please also see the operating instructions of the camcorder.

Insert the recorded cassette into the video recorder. Make sure the cassette is not protected against recording!

- 1 Switch on the TV set and select the programme position intended for the video recorder.
- 2 Switch the video recorder on.
Select the programme position "E3" or "E4".
- 3 Press the **MENU** button.
The OSD page "MAIN MENU" appears on the picture screen. Select the menu option "A/V Edit". Confirm with the **▶** button.
- 4 The OSD page "EDIT MENU" appears on the picture screen. Select the option "Insert Edit". Confirm with the **▶** button.

The OSD page "INSERT EDIT" corresponding to the connected camcorder type appears on the picture screen.

Follow the user guide on the OSD page.

- 5 Provided your camcorder has a 2.5 mm ø control socket (LANC control) **or** a 5-pin MEI-socket: Confirm the menu option "Insert VCR" **or** select the option "Insert CC". Confirm with the **▶** button.

Method 1 'Insert VCR':

- 6 Use the **RECORDER** button to select the OSD page "Recorder" (for **video recorder** mode). Search on the cassette in the video recorder the tape position where the recording is to end. Mark this position with the **EDIT OUT** button.
- 7 Search on the cassette in the video recorder the tape position where the recording is to begin. Switch the video recorder to playback-pause.
- 8 Use the **PLAYER** button to select the OSD page "Player" (for **camcorder** mode). Search on the cassette in the camcorder the tape position where the recording is to begin. Use the slider controls **L RECORD LEVEL R** to adjust the recording level so that the "0 dB" mark lights up during the loudest passages of the recording. Switch the camcorder to still picture (playback-pause).

Method 2 "Insert CC":

- 6 Use the **RECORDER** button to select the OSD page "Recorder" (for **video recorder** mode). Search on the cassette in the video recorder the tape position where the recording is to begin. Switch the video recorder to playback-pause.

Depending on the camcorder type connected, it is possible to mark the **beginning** and the **end** of the recording.

Follow the user guide on the OSD page.

- 7 Use the **PLAYER** button to select the OSD page "Player" (for **camcorder** mode). Search on the cassette in the camcorder the tape position where the insert recording is to **begin**. Use the slider controls **L RECORD LEVEL R** to adjust the recording level so that the "0 dB" mark lights up during the loudest passages of the recording. If possible, mark the **beginning** of the insert recording with the **EDIT IN** button, **or** switch the camcorder to still picture (playback-pause).

- 8 If necessary, search on the camcorder the desired **end** of the insert recording and mark it with the **EDIT OUT** button.

Follow the user guide on the OSD page.

How to start the insert recording depends on the camcorder used and the corresponding synchro-edit cable.

Variant 1. The video recorder controls the camcorder

- 9 Start copying with the **RECORD ●** button on the video recorder. The camcorder starts with "PLAYBACK" and at the same time the video recorder starts with "RECORDING".
- 10 The insert recording is automatically stopped. If you wish to stop earlier, press the **STOP ■** button on the video recorder.
- 11 Terminate insert-edit recording with the **MENU** button or the **STANDBY ◊** button on the remote control.

Variant 2. The camcorder controls the video recorder (only possible with "Insert CC").

- 9 Start copying with the corresponding button on the camcorder or its remote control. The camcorder starts with "PLAYBACK" and at the same time the video recorder starts with "RECORDING".
- 10 The insert recording is automatically stopped. If you wish to stop earlier, press the PAUSE or STILL button on the camcorder or its remote control.
- 11 Terminate insert-edit recording with the **MENU** button or the **STANDBY ◊** button on the remote control.

Note:

* If your camcorder is equipped with a 2.5 mm ø control socket (LANC control) **or** a 5-pin MEI-socket, the playback and fast wind functions of many camcorders can be controlled with the corresponding control elements on the video recorder.

The programme edit functions

You can mark up to ten (10) individual scenes from existing video recordings, transfer to the "Programme Edit" list of the video recorder, rearrange and afterwards re-record one after the other onto a video cassette.

It is a prerequisite that your camcorder is equipped with a "Bus control" and has an hour, minute, second or single picture counter (time code counter). The "Bus control" can be recognized by a 5 pin MEI socket **or** by a 2.5 mm Ø control socket (LANC control) on the camcorder.

In addition, you can control playback and fast wind functions of many camcorders with the corresponding control elements on the video recorder.

Connect the two units with the corresponding synchrono-edit cable (socket **SYNCHRO EDIT** or **MEI EDIT** on your video recorder).

The picture/sound signal is relayed via the input sockets **V** ("E3") or **S VHS** ("E4") and **L** + **R** (sound input for "E3" and "E4") into the video recorder. The sockets are located at the front of the video recorder behind a flap.

Observe the operating instructions for your camcorder. Make sure that the "correct" cassette without erase protect is placed in the video recorder.

- 1 Switch on the television set and select the programme number for the video recorder.
- 2 Switch the video recorder on and select the programme numbers of the connected picture/sound source ("E3" or "E4").
- 3 Switch on the camcorder. Insert the "correct" cassette. If the connected camcorder does not have a time code (see operating instructions of the camcorder) then set the tape length counter of the camcorder to zero at the start of the tape. The "zero point" (Reference point for the section) can be selected from any tape position.
- 4 Press the **MENU** button on the remote control. The OSD page "MAIN MENU" appears on the screen. Select the line "A/V Edit". Confirm with the **▶** button.

- 5 The OSD page "EDIT MENU" appears on the screen. Select the "Programme edit" line. Confirm with the **▶** button.
 - 6 The OSD page "PROGRAMME EDIT" appears on the screen. The line "Edit scene" is active. Confirm with the **▶** button.
 - 7 Select the scene to be edited. Switch to the OSD page "Player" with the **PLAYER** button (for **camcorder** operation). Find the **beginning** of the scene on the camcorder which you want with the **EDIT IN** button on the video recorder.
 - 8 Find the **end** of the scene on the camcorder, which you want to re-record. Mark it with the **EDIT OUT** button on the video recorder.
 - 9 Press the **RECORDER** button. The marked scene will be automatically accepted in the OSD page "PROGRAMME EDIT" (editing sequence).
- Repeat steps 7 to 9 until all the scenes required have been marked.
- 10 Quit with the **MENU** button. The OSD page "PROGRAMME EDIT" appears on the screen.

Note:

* All scenes are active and therefore marked with an asterisk (*). You can only record active scenes. With the **SELECT** button you can activate and then deactivate each individual scene.

Rearranging individual scenes

Establish the sequence of the scenes in the editing sequence before re-recording.

- 1 Call up the OSD page "PROGRAMME EDIT". The line "Edit scene" is active. Confirm with the **▶** button.
- 2 The OSD page "PROGRAMME EDIT" (editing sequence) appears on the screen. Select the scenes which you wish to relocate. Press the **▶** button.
- 3 Relocate the scene to the required position. Confirm with the **◀** button.
- 4 Quit with the **MENU** button.

Deleting individual scenes

- 1 Call up the OSD page "PROGRAMME EDIT".
The line "Edit scene" is active.
Confirm with the  button.
- 2 The OSD page "PROGRAMME EDIT" (editing sequence) appears on the screen.
Select the scene, which you want to delete.
- 3 Press the **CLEAR** button. The scene is deleted.
- 4 Quit with the **MENU** button.



Preview of scenes in the editing sequence

With this function you can look at all scenes on the editing sequence before re-recording.
If the connected camcorder does not have a time code, the video tape in the camcorder must be rewound to the tape position which has been used as the zero point during editing transfer.
The tape length counter on the camcorder must be set to zero.

- 1 Call up the OSD page "PROGRAMME EDIT".
Select the line "Preview scenes".
Confirm with the  button.
- 2 The OSD page "PREVIEW" appears on the screen.
The video recorder switches the camcorder automatically to replay and plays the scenes in the same order as the editing sequence.
- 3 At the end of the last scene the video recorder ends the replay and switches automatically to the OSD page "PROGRAMME EDIT".
- 4 If you want to quit earlier, press the **MENU** button.

Recording all scenes

With this function you can re-record all scenes which are in the editing sequence onto a video cassette.
If the connected camcorder does not have time code, the video tape in the camcorder must be rewound to the tape position which has been used as the zero point.
The tape length counter on the camcorder must be set to zero.

- 1 Call up the OSD page "PROGRAMME EDIT".
Select the line "Record scenes".
Confirm with the  button.
- 2 The OSD page "RECORD SCENES" appears on the screen.
Find the correct tape position on the video recorder for recording start. Switch the video recorder to replay-pause.
- 3 Start the re-recording procedure with the **RECORD**  button on the video recorder. The video recorder plays scene for scene onto the video cassette.
- 4 After re-recording of the last scenes the video recorder switches automatically to the OSD page "PROGRAMME EDIT".
The editing sequence data is saved.
- 5 If you want to quit before, press the **MENU** button.

Totally deleting the editing sequence

If you want to re-record "new" scenes, you must first delete the contents of the editing sequence.

- 1 Call up the OSD page "PROGRAMME EDIT".
Select the line "Delete list".
Confirm with the  button.
- 2 The OSD list "DELETE LIST" appears on the screen.
If you want to fully delete the contents of the editing sequence then press the **CLEAR** button.
- 3 The OSD page appears again briefly, the contents of the editing sequence are fully deleted.
Then the video recorder switches automatically to OSD page "PROGRAMME EDIT".
- 4 Quit with the **MENU** button.

8. ADDITIONAL FUNCTIONS OF YOUR VIDEO RECORDER

Personal preferences

For certain record and play functions, you can determine your individual settings in advance. You will find detailed explanations of the functions in the various chapters.

- 1 Switch on the TV set and select the channel number for the video recorder.
- 2 Press the **MENU** button.
- 3 Select the line "Personal preferences". Confirm this by pressing the button **▶**.
- 4 The OSD page "PERSONAL PREFERENCES" appears on screen and the "Timer" line becomes active.

PERSONAL PREFERENCES	
Timer	No preference >
Record speed	SP
OSD mode	auto
Direct Record	on
Record prepared	E2
Confirm - OK	

- 5 You can now determine which type of TIMER programming you prefer.
Select the display "No preference", "Standard Timer" or "ShowView".
- 6 By pressing the button **▼** or **▲**, select the line "Record speed". Select the display "SP" (= standard playing time) or "LP" (= long playing time).
- 7 Select the line "OSD mode".
Select the desired display.
"auto": the selected mode is faded onto the screen for a few seconds and then disappears.
"on": the selected mode is faded permanently on screen.
"off": the selected mode is not faded onto the screen.
- 8 Select the line "Direct Record". If the function is switched **on**, the video recorder will **always** record the TV channel selected (at the moment recording begins). Select the function "off" or "on".

- 9 Select the line "Record prepared". (Externally controlled TIMER recording.)
Select the display "E1" or "E2" (recordings of video/sound sources at the scart sockets **EURO-AV 1** or **DEC.-AV 2**, e.g. a second video recorder, satellite receiver, Decoder etc.).
- 10 Store the entries by pressing the button **OK**.
- 11 Complete the setting by pressing the button **MENU**.

Checking/setting time and date on video recorder

In order to make programmed recordings, the video recorder clock must first be set correctly. If a TV channel with TXT is set on channel number "01" of the video recorder, the time and date will be loaded automatically (the time also for the analogic clock).

If necessary, enter the time and date by hand.

- 1 Switch on the TV set and select the channel number for the video recorder.
- 2 Press the button **FOLLOW TV** on the video recorder.
- 3 Select the line "Clock". Confirm by pressing the button **▶**.

If the message: "Date and time loaded from P 01" appears, continue the setting with Step 6.

CLOCK SETUP	
Time	16:45
Year	1997
Month	05
Date	10
Date and time loaded from PO1	
Confirm - OK	

- 4 Select the appropriate input line. Enter the time, year, month and date. Use digit buttons **0-9** to do this.
- 5 Store by pressing the button **OK**.
- 6 Confirm the setting by pressing the button **MENU**.

Special settings for the video recorder and TV set

This is where you can make various basic settings, e.g. frequency/channel number display, wide-screen format, VCR1/VCR2 switching.

- 1 Switch the TV set on and select the channel number for the video recorder.
- 2 Press the button **FOLLOW TV** on the video recorder.
- 3 Select the line "Special settings". Confirm this by pressing the button **▶**.
- 4 The OSD page "SPECIAL SETTINGS" appears on screen and the line "Frequency/Channel" becomes active. Select the display "FREQ" or "CHAN".

SPECIAL SETTINGS	
Channel/Frequency	CHAN >
16 :9	on
VCR address	VCR1
Y/C CVBS input/output	
Beeper	on
Exit - MENU	

- 5 Select the line "16:9". If you have one of the new TV sets in wide-screen format, you need not make the setting. Otherwise, select the display "off" (= screen format "4:3").
- 6 Use two video recorders with the same remote control code so that you can switch the remote control and the corresponding video recorder to operate the "right" video recorder.
In this connection, read the detailed explanations in Chapter 8 "Additional functions of your video recorder" in the section entitled "VCR 1/VCR 2 switching".
- 7 Each time a button is pressed, whether on the Videorecorder or on the remote control, it is confirmed by an audible signal.
This audible signal can be switched off and on. Select the line "Beeper". Select "off" or "on".

You can make recordings from external picture/sound sources with this video recorder, for example re-recording from a camcorder or a second video recorder to this video recorder.

This video recorder automatically recognises whether a S-VHS signal (= Y/C-signal) **or** a VHS-Signal (= CVBS-signal) is being fed in. You can also manually choose the input and output signal of the Scart socket **1 EXTERNAL / EURO-AV 1** and also the input signal of the Scart socket **2 EXTERNAL / DEC.-AV 2**.

- 8 Select the "Y/C CVBS input/output" line. Confirm using the **▶** button.
- 9 The OSD page "Y/C CVBS INPUT / OUTPUT" will appear on the screen, the "External 1" line is active. Select the "AUTO", "Y/C" or "CVBS" display.

Y/C CVBS INPUT/OUTPUT	
Inputs :	
External 1	AUTO >
External 2	AUTO
Output :	
External 1	CVBS
Confirm - OK	

- 10 Select the "External 2" line.
If you have connected a normal VHS video recorder **or** VHS camcorder as the playback unit, then leave the "CVBS" display.
If a S-VHS video recorder **or** S-VHS camcorder has been connected, select the "Y/C" display.
If you have connected a playback unit with separate RGB outputs, then select the "RGB" display.

Note:

* In exceptional cases (e.g. when there is not a standard S-VHS or VHS signal), the colour reproduction could be distorted when the recording is played back. If this is the case, make the following setting in step 9!

If you have connected a normal VHS video recorder **or** VHS camcorder as the playback unit, then select the "CVBS" display. If a S-VHS video recorder **or** S-VHS camcorder has been connected, select the "Y/C" display.

- 11 Confirm the settings using the **OK** button.
- 12 Press the **MENU** button twice to end.

The TXT decoder. Reading TXT with the video recorder

With this video recorder, you can receive TXT programmes broadcast in your country (e.g. Videotext / Teletext / Top / Flof / Fastext / Supertext, etc.), even if your TV set is not provided with the TXT function.

Beside the comprehensive offer of TXT pages, this function offers you two further advantages:

- With your video recorder, you can visualize and record TXT subtitles.
- For record programming, you can take advantage of the convenient help provided by the TXT TV programme overview pages.

How can I read TXT?

- 1 Switch on the TV set and select the programme position intended for the video recorder.
- 2 Switch the video recorder on.
- 3 Select on the video recorder the TV programme the TXT pages of which you wish to read. For this, use the **▼** or **▲** button or the numeric buttons **0-9** on the remote control.
- 4 Press the **MENU** button on the remote control. The OSD page "MAIN MENU" appears on the picture screen.
- 5 Select the option "Easy Textprogramming". Confirm with the **▶** button.

- 6 The OSD page "EASY TEXTPROGRAMMING" appears on the picture screen. The selected programme position (e.g. "01 ARD") and one Teletext page (e.g. "100") are highlighted.

EASY TEXTPROGRAMMING				
Programme	Page			
01 ARD	100	100	100	100
02 ZDF	100	100	100	100
03 RTL	100	100	100	100
04 SAT1	100	100	100	100

Select programme - ▲ V
 Enter page - SELECT Textprog. - OK
 Select page - < > Exit - MENU

- 7 Now you can select the TXT pages which you would like to read with the **▶** button and call them up with the **OK** button. If you wish to have an overview about the entire TXT information offer, press the **◀** button and then the **OK** button. A programme-specific TXT overview page will appear, **or** enter the number of the desired TXT page with the numeric buttons **0-9**. The number must always be entered as three digits.

The entered page number appears at the left in the top information line on the picture screen. After a few seconds search time, the page appears on the screen. If you wish to read another page, simply enter the new page number.

With some TV channels, you can use the **◀** or **▶** button on the remote control to directly call up the desired TXT page.

- 8 Press repeatedly the **MENU** button until the "normal" TV programme appears on the picture screen.

Note:
 * You can store four pages as preferred pages. To do this repeat points **1** to **6**. Use the **▶** button to select the position where the new page should be stored and confirm with the **SELECT** button. Enter the new page number with the numbered keys **0-9** and confirm with the **OK** button.

Externally controlled TIMER recording

Do you have another device, such as a satellite receiver, equipped with an integrated clock which can be used for controlling other devices?

If so, you can control the recording from such an external device via the Scart socket [DEC-AV 2] or [EURO-AV 1].

Insert a cassette not protected against recording.

- 1 Switch the video recorder off with the [STANDBY ⏻] button on the remote control.
- 2 Press the [MONITOR] button on the remote control for **more than three seconds**. In the video recorder's display appears, e.g. "E2 REC PREP". The video recorder is prepared for recording.
- 3 Recording is started and stopped by remote control via the Scart socket [DEC-AV 2] or [EURO-AV 1].
- 4 If you wish to terminate the function **before** a recording is started, press the [MONITOR] button a few seconds until the video recorder switches off.
- 5 If you wish to abort the function **during** a running recording, press the [STANDBY ⏻] button.

Notes:

- * It is **not** possible to use a decoder with this function.
- * If the video recorder is prepared for externally controlled recordings, it cannot be switched in the "save energy" mode.

Tuner mode. Your video recorder as an extension of your TV set

You can also use your video recorder as a TV receiver (tuner). This is handy if your TV set does not have a remote control or if it has fewer programme positions than the number of channels it could actually receive. A decoder connected can be used.

Proceed as follows:

- 1 Switch on the TV set and select the programme position intended for the video recorder.
- 2 Press the [STOP ■] button for **more than 3 seconds**. The video recorder's display indicates the station name and the current time.
- 3 Select the desired programme position number with the [▼] or [▲] button, or enter the number as one or two digits with the numeric buttons [0-9].
- 4 Switch the video recorder off with the [STANDBY ⏻] button if you do no longer wish to view TV.

Interface RS 232

You can control your video recorder via the [RS 232] socket. The video recorder receives and transmits data according to the PC-VCR standard and generates in addition Rapid Time Code data according to the GSE standard.

That is why the units connected to the video recorder must meet the PC-VCR standard and must be adjusted to the VR 969.

For detailed information about the functions available see the manuals supplied with the external hardware or the software used.

For detailed information about the PC-VCR standard please contact a consumer help desk indicated in the guarantee leaflet.

Note:

- * Switch your video recorder to "STOP". During operation via the RS 232 interface press no button on the video recorder or the remote control handset.
- * Correct operation can only be guaranteed for the products stating the VR 969 in their operating manual.
- * The manufacturer will in no event be liable for consequential damages resulting from the use of GSE-RAPID, in particular when generating video tapes in the PLAY mode at a later date.

Recording from another video source

With this video recorder, you can make recordings from an external video source, for example a second video recorder or a camcorder.

To do this, a Scart cable will be required.

- 1 Connect this video recorder with the unit you wish to record from, for example a second video recorder.

For this, connect the Scart socket of each unit with a Scart cable. On this video recorder, use the

DEC-AV 2 Scart socket.

Note:

* In the following example, your video recorder is used as recording recorder and is referred to as VCR B. The second video recorder is used for play-back and is referred to as VCR A.

- 2 Insert a recorded cassette into VCR A and a cassette without erase protection into VCR B.
- 3 Select the programme position "E2" on the VCR B. This is to be found next to the programme position "P 01" ("P 01" - "E1" - "E2" - "E3"). For this, use the **▼** or **▲** button.
- 4 To start recording, press the playback button, for example **PLAY ►**, on the VCR A and the record button **RECORD ●** on the VCR B.
- 5 To stop copying, press the **STOP ■** button on both video recorders.

Audio only record

You can use your video recorder as a hifi tape recorder.

This means that only the stereo or dual sound is recorded from an external sound source (e.g., hifi equipment, second video recorder, etc.).

Connect your hifi (stereo) unit with an audio connecting lead to the **AUDIO L IN R** at the back of the video recorder.

Insert a cassette without erase protection into the video recorder.

- 1 Press the **MENU** button.
Select the option "Record modes".
Confirm with the **▶** button.
- 2 The OSD page "RECORD MODES" appears on the picture screen.
Select the option "Audio only record".
- 3 Switch on the sound source.
Start sound recording at the desired moment with the **RECORD ●** button.
The OSD page "AUDIO ONLY RECORD" appears on the picture screen

The video recorder records the sound from the external sound source. The sound level is automatically controlled. The video recording on the cassette is erased.

- 4 To interrupt the recording, press the **STOP ■** button.
- 5 To terminate this function, press the **MENU** button or the **STANDBY ◊** button on the remote control.

View mode

You can view the picture from an external unit connected to the socket **DEC-AV 2** of your video recorder on the picture screen (monitor) of a TV set. The external unit can be, for example, a second video recorder, a decoder or a satellite receiver.

- If the external unit transmits a control signal, this is recognized by the video recorder and this switches automatically to the view mode.
You can switch the view mode on and off with the **MONITOR** button.

Notes:

- * If the programme position "E1" or "E2" is selected, the video recorder cannot switch in the view mode. This also applies for programme positions with activated decoder function.
- * This function is **only** possible if the TV set is equipped for it and a Scart cable is used for the connection.

The TV monitor function

Press the **MONITOR** button to switch the TV set to the "AV" (= **A**udio/**V**ideo input) programme position. This is useful if you wish to monitor a "running" recording on the picture screen (monitor) of your TV set. For this, the video recorder must be switched on. The video recorder's display indicates briefly "VCR MON".

A further pressure on the same button switches the monitor function off. The video recorder's display indicates briefly "TV MON".

Notes:

- * The monitor function is **only** possible if the TV set is equipped for it and a Scart cable is used for the connection.
- * During playback, the **MONITOR** button has no function.

Switching between VCR 1 and VCR 2

This function is very useful if you have two video recorders operating with the same remote control code. So that you always control the "right" video recorder, you simply change the remote control code of this recorder and of this remote control handset.



- 1 Switch on the TV set and select the programme position intended for the video recorder.
- 2 Press the **FOLLOW TV** button on the video recorder.
The OSD page "INSTALLATION MENU" appears on the picture screen.
- 3 Select the option "Special settings".
Confirm with the **▶** button.
- 4 The OSD page "SPECIAL SETTINGS" appears on the picture screen.
- 5 Select the option "VCR Address". On the picture screen appears the message "To change – alter remote control code first".
- 6 Press **simultaneously** the numeric button **2** and the **OK** button on the remote control.
The code of the remote control is changed.
To undo the change, press the numeric button **1** and the **OK** button.
- 7 Point the remote control at the video recorder and press **any** button (e.g. **STOP**) button on the remote control. The "new" remote control code is sent to the video recorder. In the OSD page appears the indication "VCR2".
The code of the video recorder is also changed.

SPECIAL SETTINGS	
Channel/Frequency	CHAN
16 :9	on
VCR address	VCR1
Y/C CVBS input/output	
Beeper	on
To change - alter remote control code first	
Exit - MENU	

- 8 Complete the setting by pressing the button **MENU** twice.

Playback via the aerial cable

If you do not wish to use a Scart cable, you must use the **already connected aerial cable** for playback from the video recorder.

- 1 Switch on the TV set and select the programme position intended for the video recorder (see the operating instructions of your TV set).
- 2 Press the buttons  and  (Playback) on the video recorder simultaneously. A test picture emitted by the video recorder appears on the picture screen. "MODULATOR" appears in the video recorder display with a channel number and frequency.
- 3 You must enter and save this channel number or frequency on your TV set.

How to proceed on the TV set to enter the channel number or frequency is described in its operating instructions.



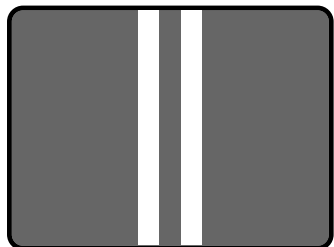



The video recorder transmits a test picture which appears on the picture screen of the TV set.



Note:
 * When later playing back from the video recorder, check the picture and sound quality on the picture screen of the TV set. If necessary, finetune the picture, colour and sound by re-adjusting the channel on the TV set.

Information: your video recorder occupies UHF channel 36. However, it is possible that in your reception area this channel is already occupied by another TV station. In this case, the picture quality of one or more TV stations on the TV may be reduced.





If this should be the case, proceed as follows:

- 4 Check whether all TV channels function exactly as they did before. If the picture quality of one or more TV channels has disimproved, switch off the video recorder for checking purposes. Check all the TV set's channels again.
- 5 If picture interference only occurs when the video recorder is switched on, you must search for a 'free' video recorder channel.
- 6 Press the video recorder buttons  and  (Playback) simultaneously.
- 7 Press the video recorder button **FOLLOW TV**. The video recorder searches for a 'free' channel. The message 'MODULATOR' and e.g. 'C44' or '655' appears on the video recorder display.
- 8 Reset the TV to the video recorder (Step 3). Store the setting by pressing the button **OK**.
- 9 If the result is unsatisfactory, you can also enter the channel number or frequency manually.
- 10 Search for a free channel on your TV set (screen only flickers).
- 11 Press the video recorder buttons  and  (Playback) simultaneously. Using the buttons  or  or the digit buttons **0-9**, enter the 'new' channel number or frequency of your TV set. You will see the test picture. Store the setting by pressing the button **OK**.
- 12 Check all channels on the TV set again. Repeat the setting (steps 10 and 11) until such time as you can no longer detect a difference in the picture between when the video recorder is switched on and when it is off.
- 13 Switch off the video recorder by pressing the button **STANDBY**.

Note:
 * If you interrupted the setting described in Chapter 2 'INSTALLATION', continue with initial installation.

Switching the built-in modulator on and off

In the previous section, possible TV reception interference was discussed. If picture/sound interference **cannot be eliminated** using the methods mentioned, the built-in modulator can be switched off. "Playback via the aerial cable" is **no longer possible** when the modulator is switched off.



- 1 Press the buttons  and  (Playback) on the video recorder simultaneously.
- 2 Press the cursor button  **for more than five seconds**. A message, e.g. "MODUL OFF", appears in the video recorder display.
- 3 Press the cursor button  again **for more than five seconds**.
A message, e.g. "MODULATOR", appears in the video recorder display.
- 4 Store the setting by pressing the button .

Note:

* If your TV set has the "Easy Link" function, and the TV set and video recorder (scart socket ) are connected with the special Scart cable supplied, the modulator is automatically switched off.

Remote control of TV sets

Your remote control can operate with a number of remote control codes for TV sets of different makes. Using the appropriate **code number** and the **TV** key group, you can adjust the volume, mute the TV sound, select the programme positions, and switch the TV set off.

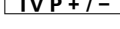
	TV volume +/-
	TV sound on/off
	TV off
	TV programme +/-

- 1 Direct the remote control at the TV set.
- 2 Press the  button and the numeric button **at the same time**.

List of several makes:

Numeric button	TV make
0	Philips, Radiola (F), Schneider (F)
1	Grundig
2	Panasonic
3	Panasonic
4	Sony

Note:

* For Panasonic, Sony, Radiola, and Schneider TV sets, the correct function of the remote control cannot be guaranteed for all types.

* If the selected code does not operate with your TV set, or if the TV make is not contained in the list, you can try out the codes one after the other.

9. NOTES

Safety instructions/notes

- Do not use your video recorder immediately after moving it from a cold to a warm location or vice versa, or under conditions of high humidity. Before setting up the video recorder, it should be allowed to acclimatise for at least three hours after unpacking.
- Do not place the video recorder close to sources of heat (radiators, etc.)
- Ensure that air can circulate freely through the video recorder's ventilation openings. Do not place the video recorder on soft surfaces.
- Ensure that there is a vertical distance of at least 20 cm between the video recorder and your TV set.
- Do not use the video recorder in dusty places or where it may be subject to vibration. During severe thunder-storms (with lightning), we recommend disconnecting the video recorder from the mains and the aerial .
- Do not put your fingers or any other foreign objects into the cassette loading slot as this could damage the drive mechanism. Be particularly careful with children.
- This video recorder operates in accordance with the VHS cassette standard. Use only cassettes of a **well-known brand** which display the VHS symbol. We recommend that you use PHILIPS VHS video cassettes to ensure the **best possible picture quality** from your video recorder.



- ShowView is a trademark applied for Gemstar Development Corp. ShowView system manufactured under licence from Gemstar Development.

SHOWVIEW

- This operating manual is printed on chlorine-free paper. Used batteries should not be thrown away with ordinary domestic refuse. Deposit old batteries at appropriate collection points. This is to help protect our environment. All electronic appliances contain many materials which can be recycled. Inform you about the recycling possibility for your old appliances.



Please keep the box and packing material for future shipments.

10. BEFORE YOU CALL A TECHNICIAN



Problem

The video recorder does not respond when a button is pressed

Possible cause

- No power supply.
- Programmed recording is in progress.
- Technical disturbance: disconnect from the mains for 30 seconds, then reconnect.

If this has no effect, you can:

1. Disconnect the mains plug from the video recorder.
2. **Press and hold down** the  button on the video recorder while reconnecting the mains plug. **Hold down** the  button until horizontal lines (-- : --) appear in the video recorder's display. **All data memories** are reset (cleared).

The remote control does not work

- Batteries are weak.
- Interference from fluorescent lamps or bright sunlight.

No playback from the video recorder

- No recording on the cassette
- Cassette has reached the end.
- The programme position for the video recorder has been incorrectly selected or incorrectly set.
- The connection cable between the TV set and the video recorder is interrupted.
- "Modulator" not in "on" position.

Poor playback from the video recorder

- When using hired cassettes - during playback: switch on the function "Tracking"
- Cassette is badly worn or of poor quality.
- Bad adjustment of the TV set.
- Video heads are dirty. During playback: switch on the function "Head cleaning". This will clean the video heads.

Recording not possible

- TV channel not stored or incorrectly selected.
- A cassette with erase protection has been inserted.

Programmed recording does not work

- Time data programmed incorrectly.
- Time/date are not properly set.
- A cassette with erase protection has been inserted.
- Cassette has reached the end.
- PDC/VPS was switched on, but the "PDC/VPS time code" was incorrect.
- Video recorder was not switched off – ( button on the remote control).

Picture/sound distortions during TV reception

- Read the note in chapter 8 "Additional functions" in the paragraph "Playback via the aerial cable" after point 5, as well as the paragraph "Switching off the modulator".

11. TECHNICAL DATA, ACCESSORIES

Technical data

- Mains voltage 220 - 240 V~
- Mains frequency 48-52 Hz
- Power consumption 25 W typical
(typ. 20 W in standby)
(typ. ≤ 1 W in low power mode)
- Wind/rewind time, 90 s typical for E-180
- Ambient temperature during operation
+10°C to +35°C
- Relative humidity 20 % bis 80 %
- Weight approx. 5,4 kg
- Position for use max.15° tilt in all directions
- Video resolution S-VHS ≥ 400 lines
VHS ≥ 240 lines
- FM audio (SP) 20Hz - 20KHz (≤ 3 dB)
- Power failure protection: transmitter 1 year typical,
clock/timer 7 hours typical
- Dimensions 380 x 280 x 94 mm
(including feet)
- The video recorder meets the requirements
of the 73/23 EC + 89/336 EC + 93/68 EC
guidelines.

Accessories supplied

- Mains cable
- Aerial cable
- Audio cable
- Scart cable (Euro-AV cable)
- SVHS cable
- Remote control with batteries
- Operating instructions

In order to identify your video recorder in case of theft, enter the serial number (PROD NO.) where indicated. The serial number is printed on the type plate fixed at the rear of your video recorder. Customer service enquiries can be handled more efficiently if you provide the data indicated on the type plate. Therefore, keep this page in a safe place.

MODEL NO: VR 969
PROD. NO: VN

PHILIPS SYNCHRO-EDIT CABLE

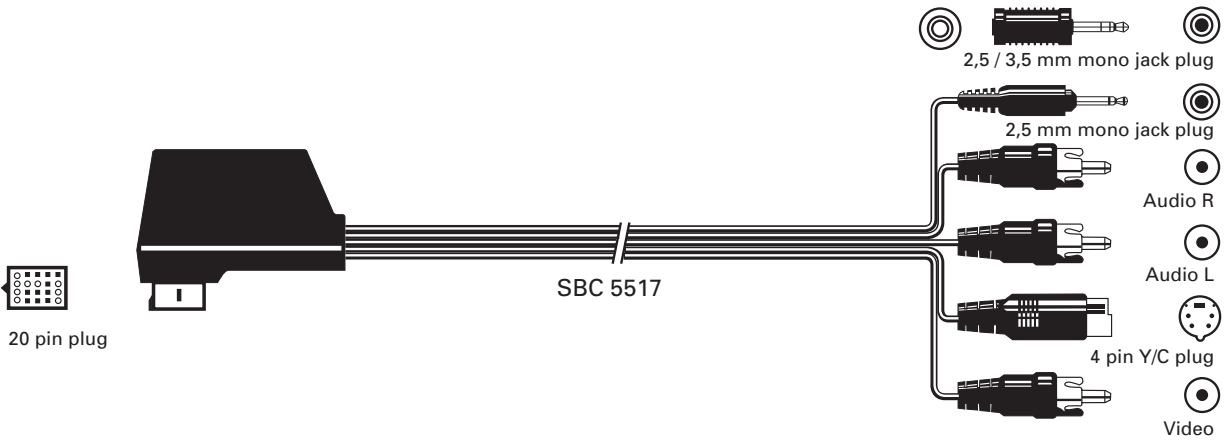
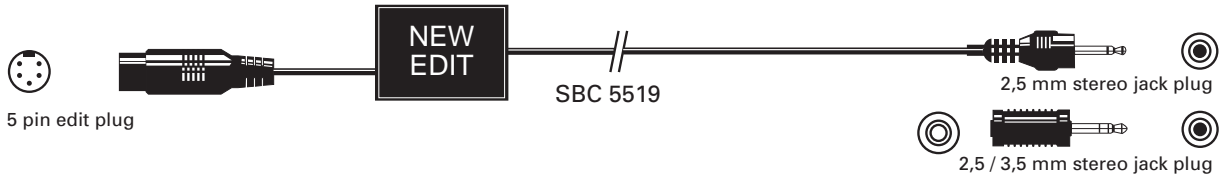

VR 969/02



3112 416 09391
8071/001